

Willow Wardrobe

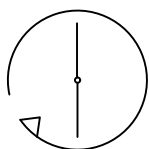

Up to 60 minutes
assembly time

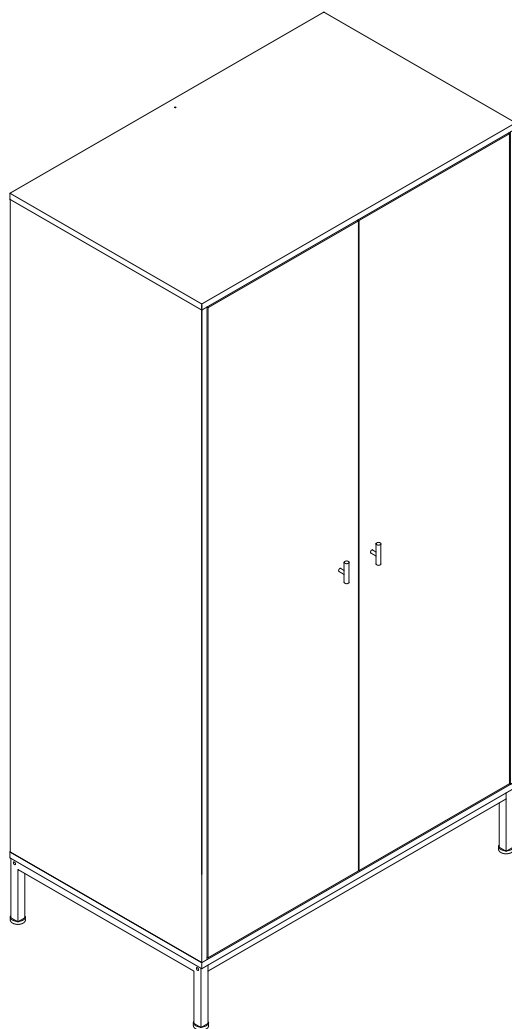
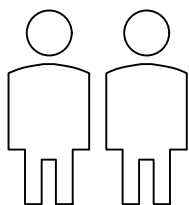

Two person
assembly

This product is intended for domestic use only, not for commercial purposes.

IMPORTANT

ASSEMBLY TIP

Before you begin, it's best to identify all of the parts and fittings to build your Willow Wardrobe frame. We advise laying these out on the floor to check you have everything, and to familiarise yourself with all of the parts and fittings before building.

TOP TIP

We recommend that you assemble the Willow Wardrobe in the room you'd like it to be located. This will help prevent any risk of damage to the frame whilst moving it.

SAFETY AND CARE

It's important to ensure children and animals are kept away from the assembly area, as there are small components used in this product which could present a choking hazard. All plastic and wrapping materials should also be kept away from children and animals to prevent any risk of suffocation.

HELP AND SUPPORT

Please contact our customer service team on 0113 519 0311 if you have any questions or issues with your purchase.

RECYCLING

Please ensure that packaging is disposed of in a safe and environmentally friendly way, and recycle where possible. Please keep your assembly instructions safe to refer back to in the future.

CARE AND MAINTENANCE:

1. Only clean using a damp cloth, do not use bleach or abrasive cleaners as they may damage the finish over time.
2. Do not use a very wet cloth or allow any liquid to contact with the veneer for a long period of time. Wipe any spillage immediately. Absorption can cause wood to warp or finishes to de-laminate.
3. Do not scrub or rub the surface when cleaning.
4. Do not drag the Willow Wardrobe when moving, lift it off the floor instead.
5. Use a placemat or a coaster when putting hot items (e.g. hot drinks and dishes) on the wood surface.
6. It is not recommended to place the item next to sources of heat such as radiators, fires or directly exposed to sunlight. This may cause the wood to crack, split or fade due to the heat and humidity.
7. Wood will mellow and change colour over time, we recommend that ornaments and items placed on the surface to be moved regularly to prevent uneven mellowing.
8. Regularly check all fixings to ensure none have come loose. Re-tighten if necessary.
9. Avoid sharp items such as a screwdriver or any pointy tools.
10. Dispose of all packaging carefully and responsibly - recycle where possible.

Parts list











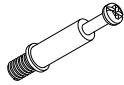







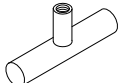

Before you begin building your Willow Wardrobe, please take a moment to read through the instructions and make sure that you have all the relevant parts listed on the parts check list.

Part Number	Part Description	Quantity
①	Left Side Panel	1pc
②	Right Side Panel	1pc
③	Top	1pc
④	Back Panel	2pcs
⑤	Back slats	1pc
⑥	Centre Support	2pcs
⑦	Clothes Poles	1pc
⑧	Centre Support	1pc
⑨	Shelf Panel	1pc
⑩	Bottom Panel	1pc

Part Number	Part Description	Quantity
⑪	Leg	2pcs
⑫	Leg Side Support	2pcs
⑬	Door Panel	2pcs

Fittings

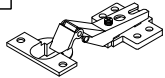
Please check you have all the fittings listed below with your product.

<p>A</p>  <p>M6*35mm Bolt 17pcs+1pc extra</p>	<p>B</p>  <p>Ø15x9.5mm Cam Lock 17pcs+1pc extra</p>	<p>C</p>  <p>Ø8x30mm Dowel 20pcs+2pcs extra</p>	<p>D</p>  <p>M3.5*12mm Screw 4pcs</p>	<p>E</p>  <p>M3*14mm Screw 12pcs+1pc extra</p>
<p>F</p>  <p>M4*35mm Screw 1pc</p>	<p>G</p>  <p>M5*40mm Screw 6pcs</p>	<p>H</p>  <p>M4*20mm Screw 2pcs</p>	<p>I</p>  <p>15x9mm Plastic Buckle 12pcs+1pc extra</p>	<p>J</p>  <p>Handle 2pcs</p>
<p>K</p>  <p>M4*14mm Screw 1pc</p>	<p>L</p>  <p>Wall Bracket 1pc</p>	<p>M</p>  <p>3mm Allen Key 1pc</p>	<p>N</p>  <p>Ø6x30mm Wall Plug 1pc</p>	<p>O</p>  <p>4mm Allen Key 1pc</p>
<p>P</p>  <p>M6*35mm Screw 4pcs</p>	<p>Q</p>  <p>Clothes Tray 2pcs</p>	<p>R</p>  <p>M3*14mm Screw 12pcs+1pcs extra</p>	<p>S</p>  <p>M4*14mm Screw 36pcs+2pcs extra</p>	<p>T</p>  <p>Hinge 6pcs</p>
<p>U</p>  <p>M6*30mm Screw 10pcs extra</p>	<p>V</p>  <p>Cover 10pcs</p>			

Parts list

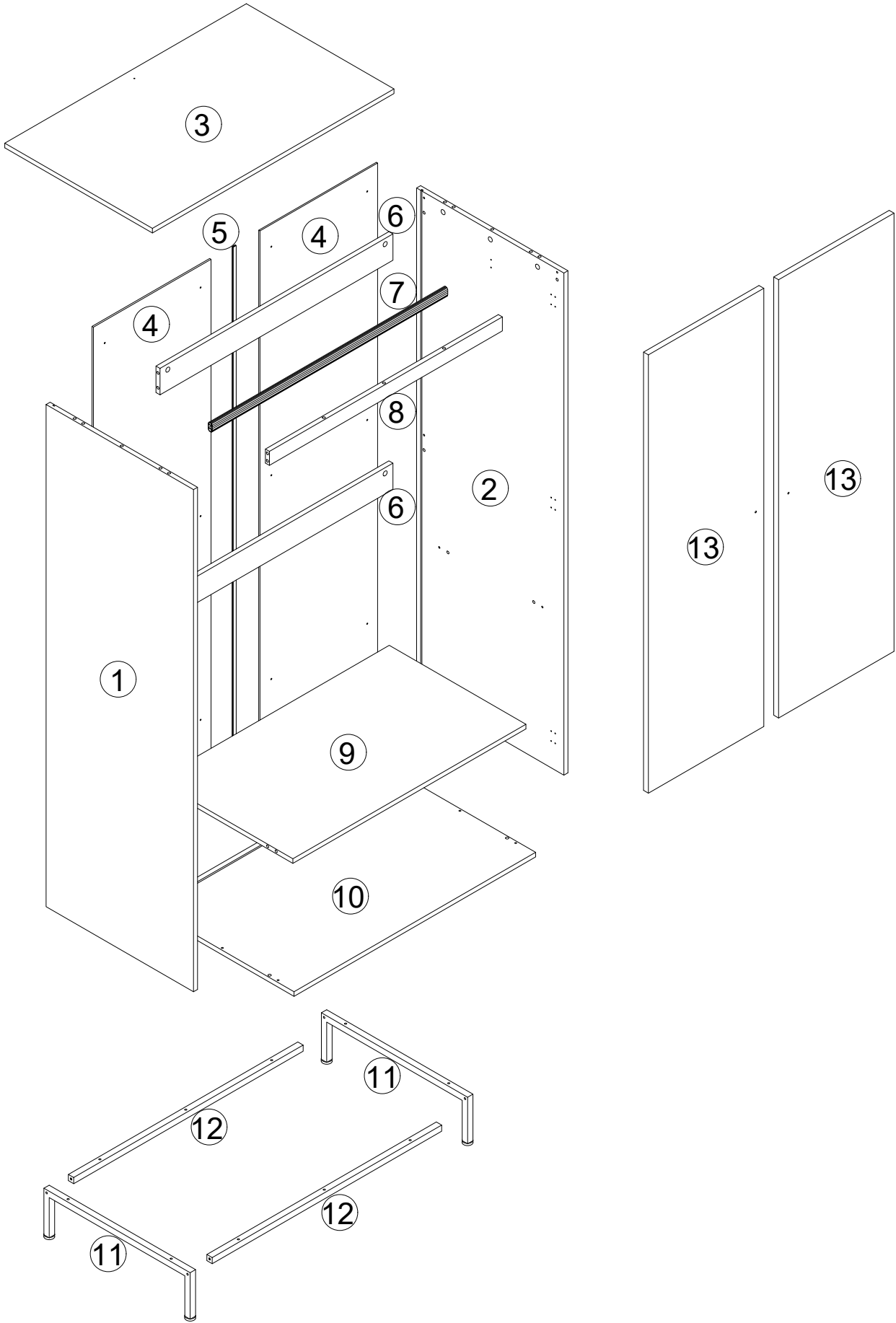

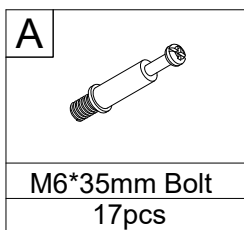
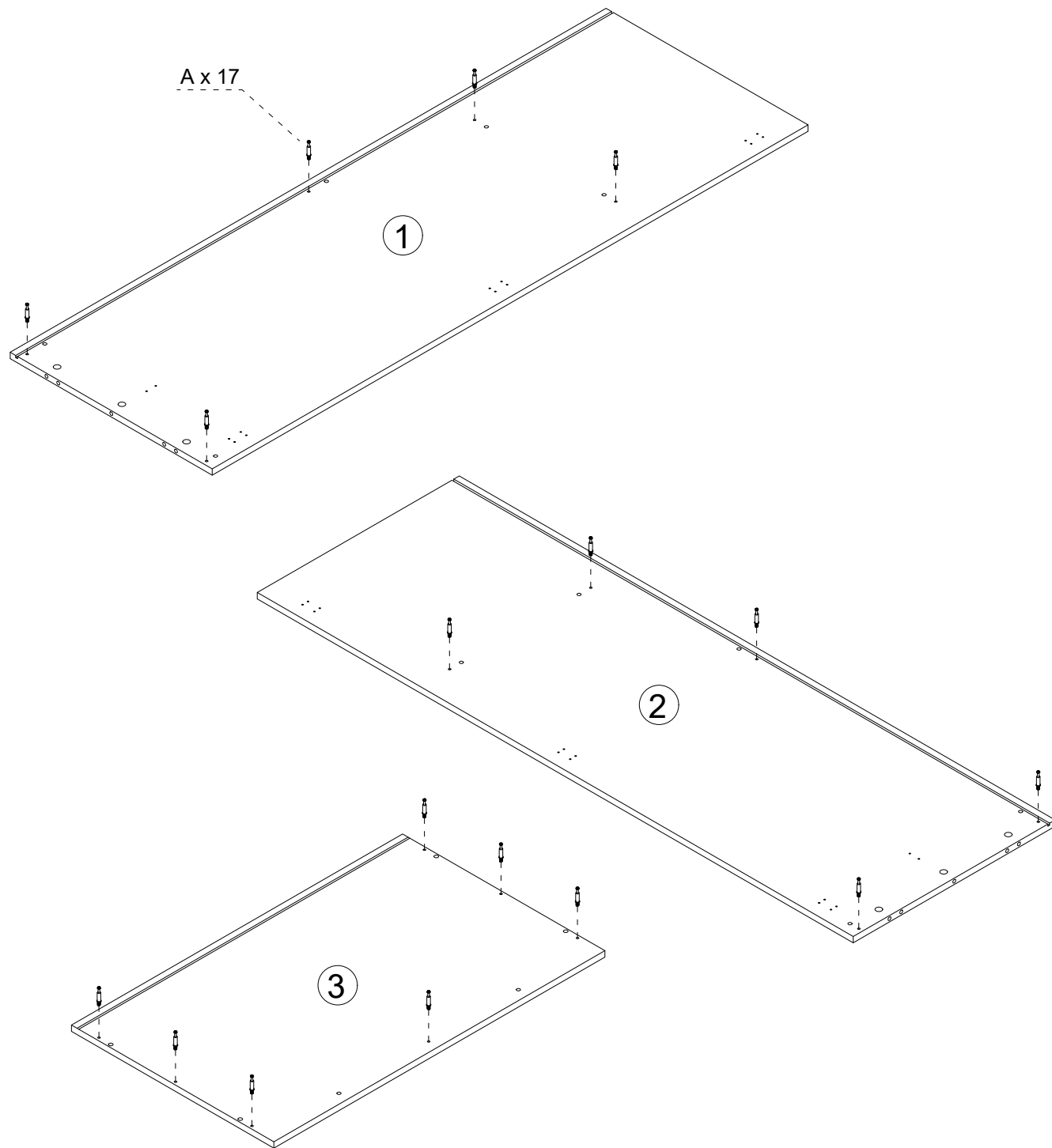

1. Attach parts to the boards.

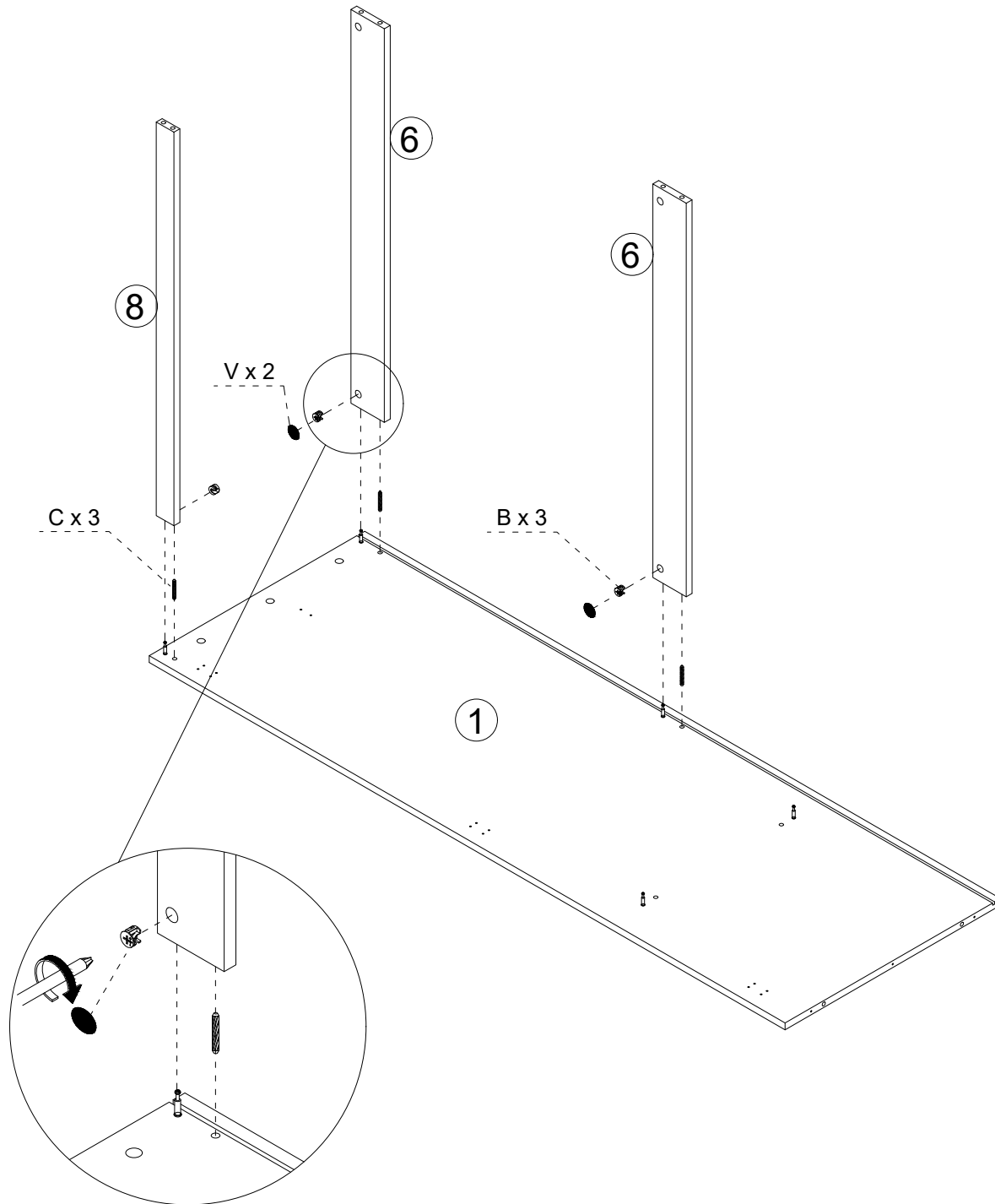

2. Attach parts to the boards.





B	
Ø15x9.5mm Cam Lock	
3pcs	

C	
Ø8x30mm Dowel	
3pcs	

V	
Cover	
2pcs	

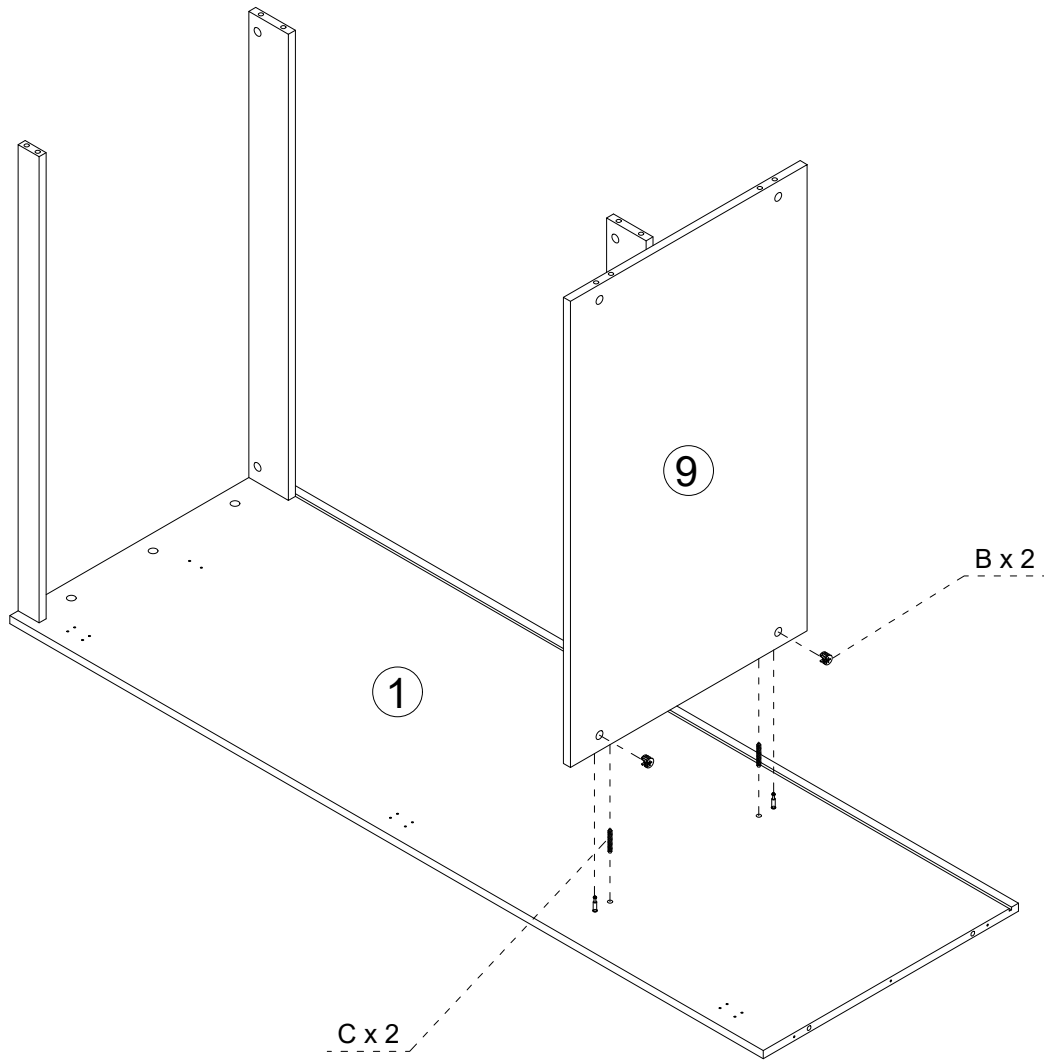
3. Attach parts to the boards.





B	
Ø15x9.5mm Cam Lock	
2pcs	

C	
Ø8x30mm Dowel	
2pcs	

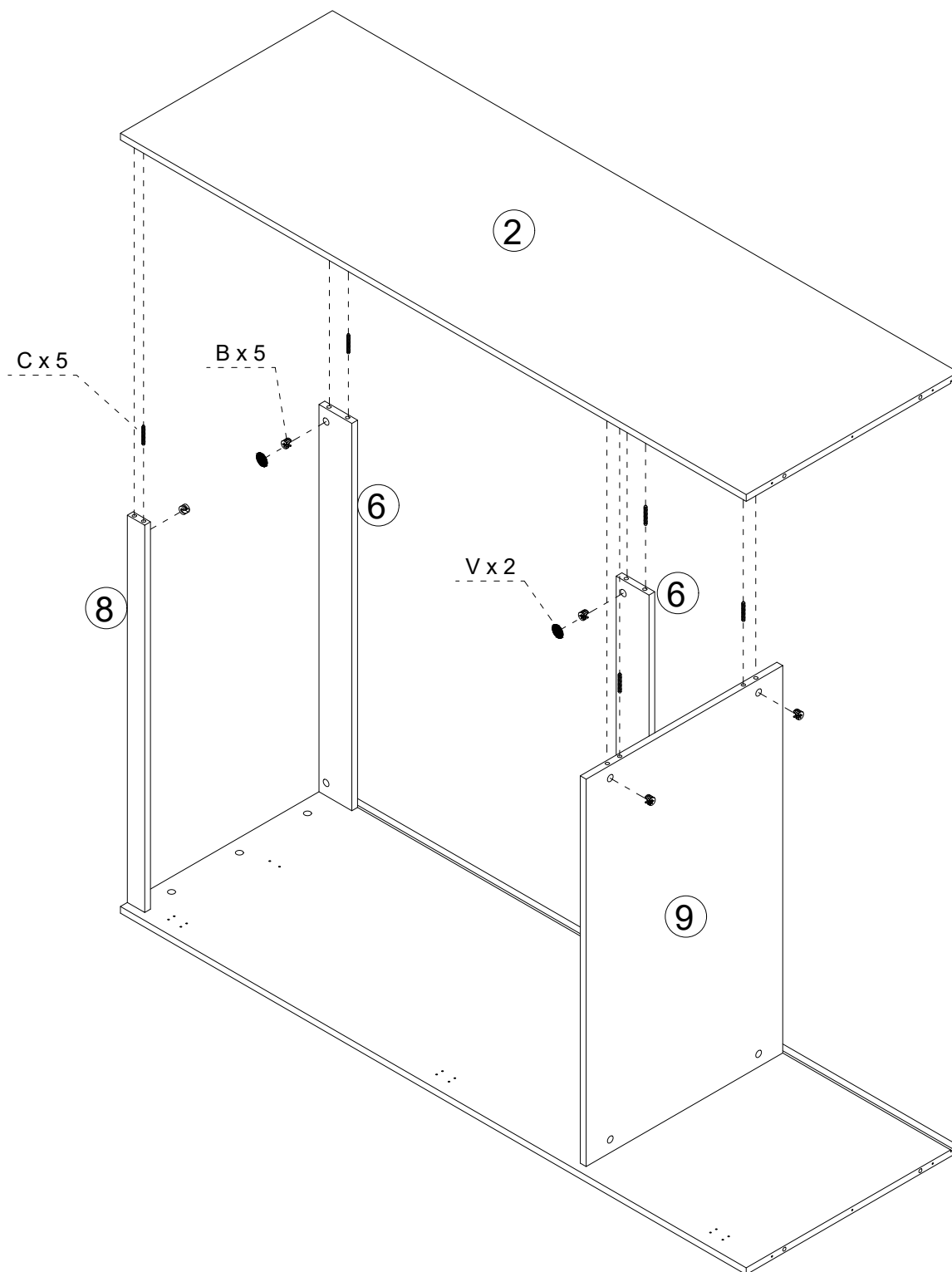
4. Attach parts to the boards.



B	
Ø15x9.5mm Cam Lock	
5pcs	

C	
Ø8x30mm Dowel	
5pcs	

V	
Cover	
2pcs	

5. Assemble the top to the frame.

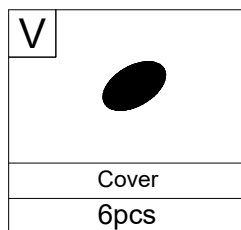
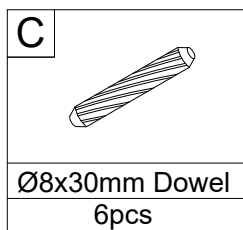
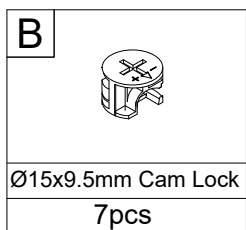
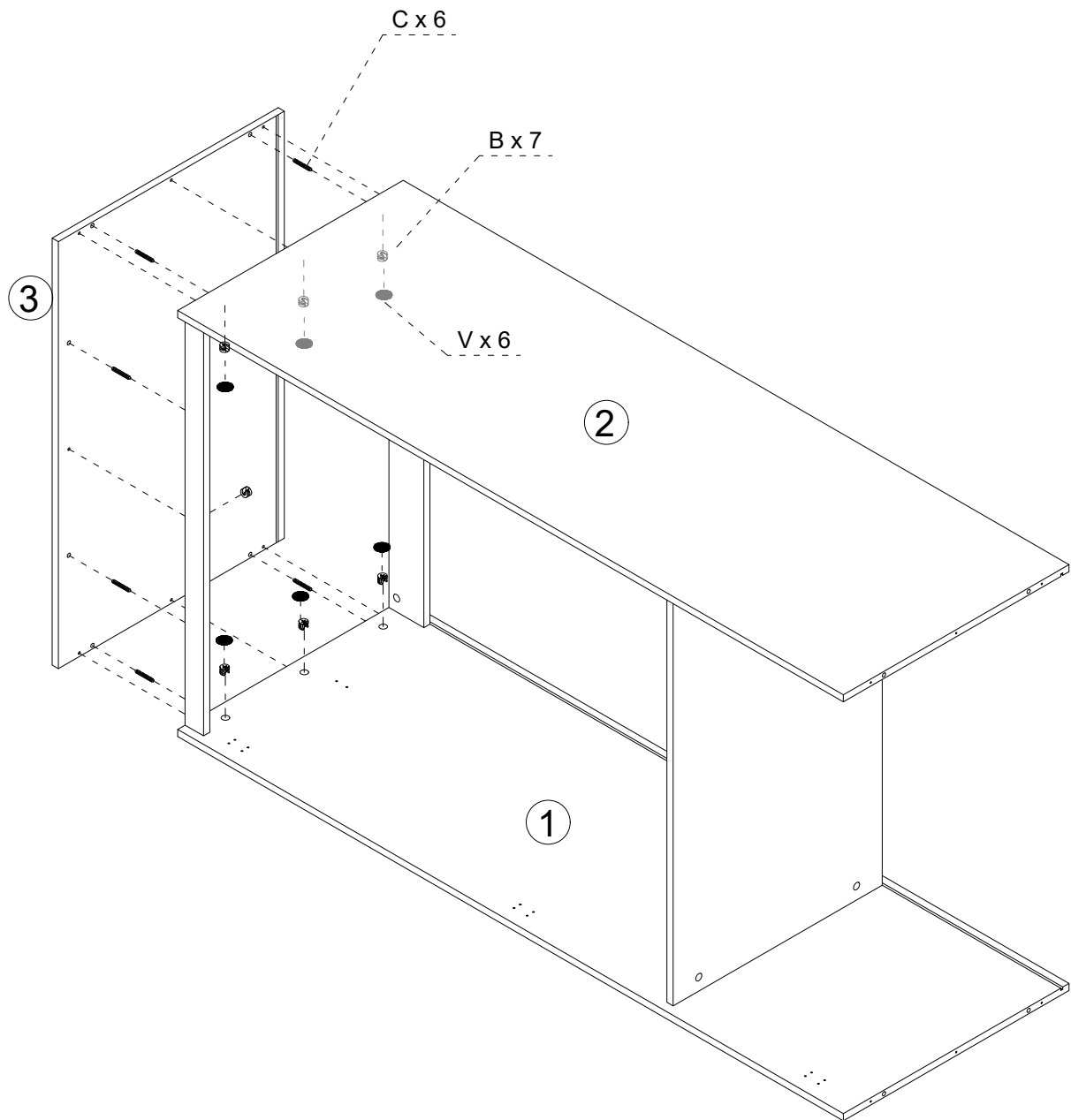

6. Assemble the boards to the frame.

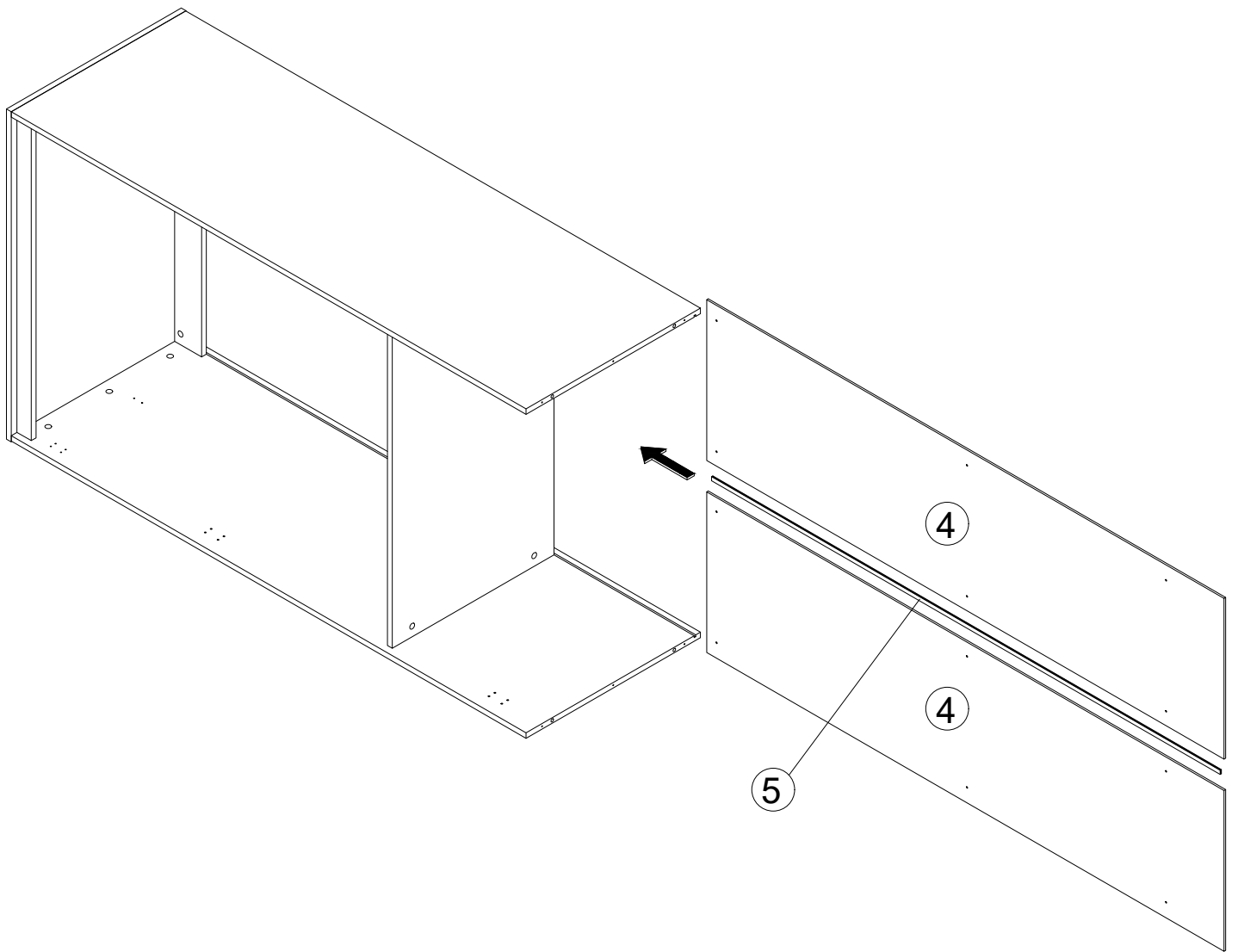

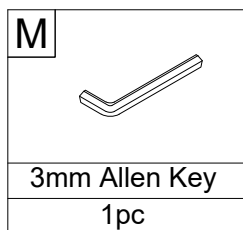
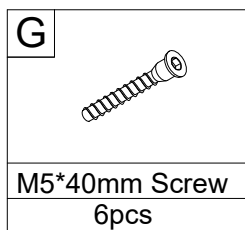
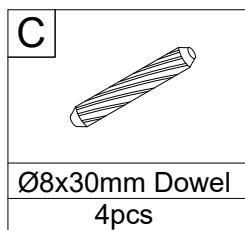
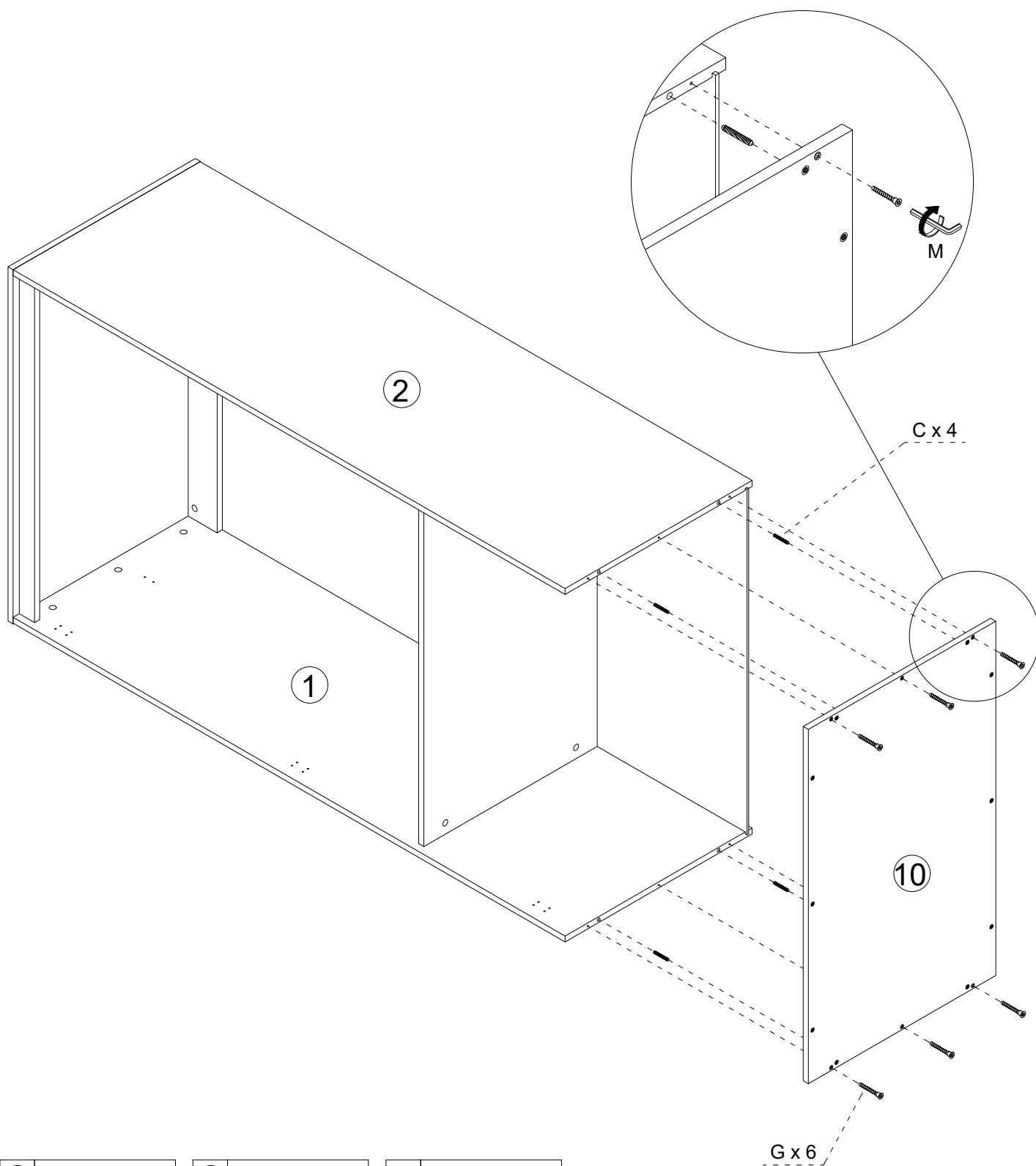

7. Assemble boards to the frame.

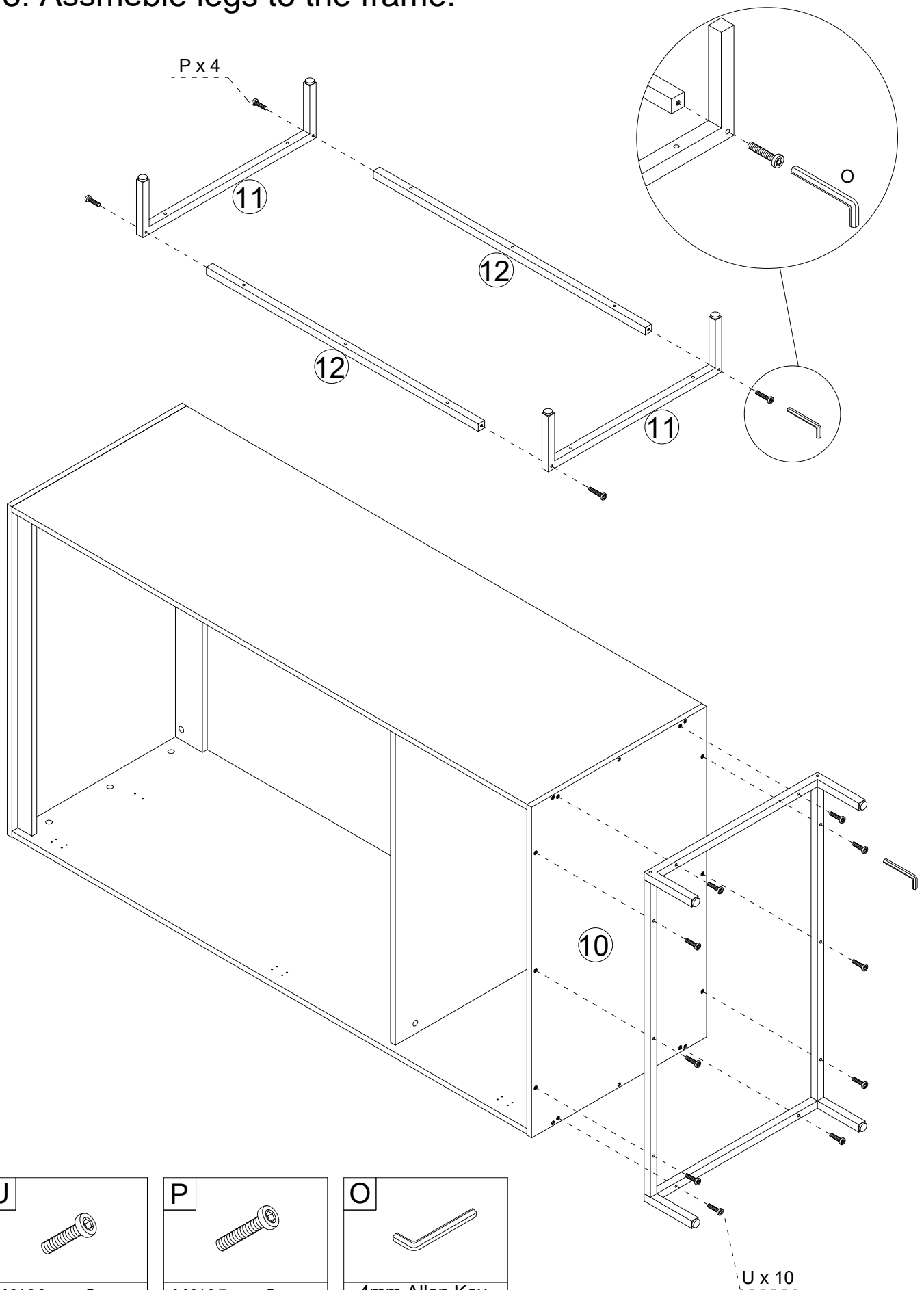

8. Assemble legs to the frame.



U	
M6*30mm Screw	
10pcs	

P	
M6*35mm Screw	
4pcs	

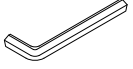
O	
4mm Allen Key	
1pc	

U x 10

9. Assemble parts to the frame.

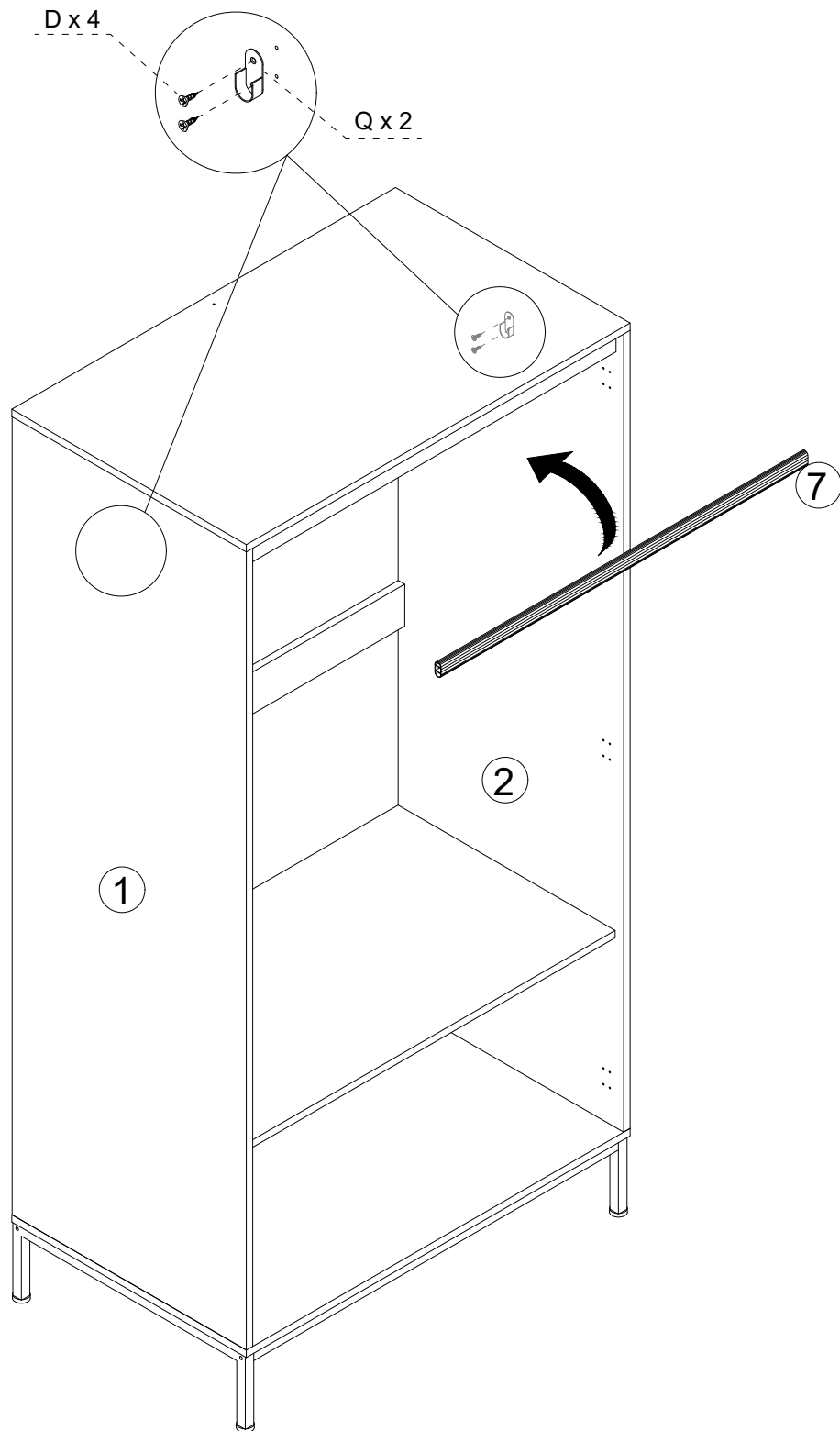

D	
M3.5*12mm Screw	
4pcs	

Q	
Clothes Tray	
2pcs	

10. Attach parts to the boards

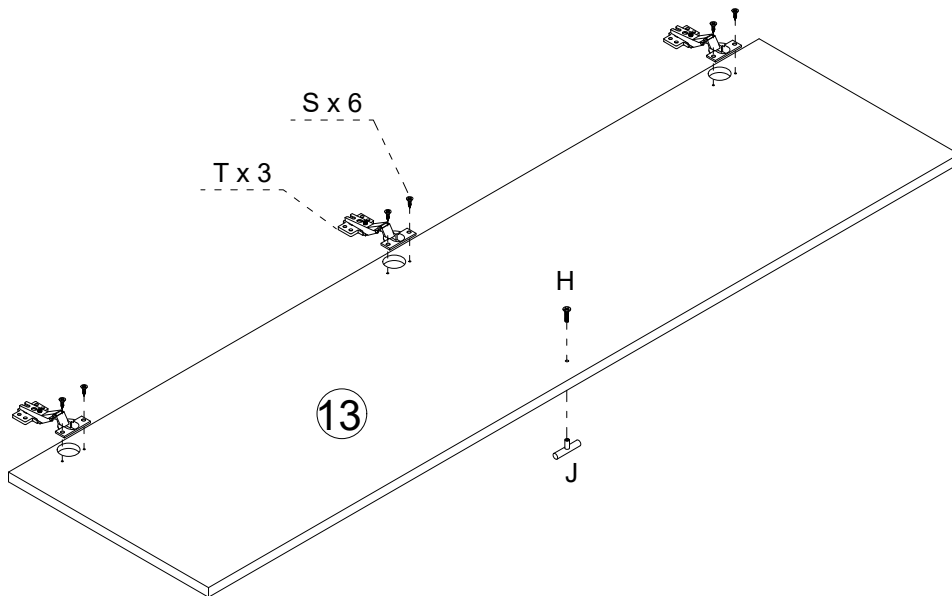

x 2

S	
M4*14mm Screw	
12pcs	

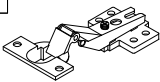
T	
Hinge	
6pcs	

H	
M4*20mm Screw	
2pcs	

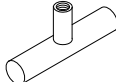
J	
Handle	
2pcs	

11. Assemble doors to the frame.

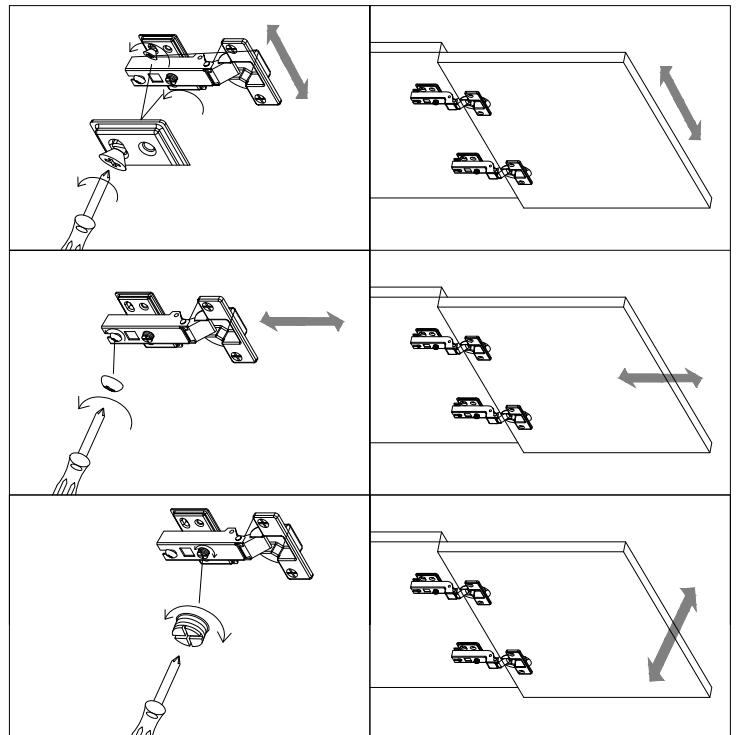
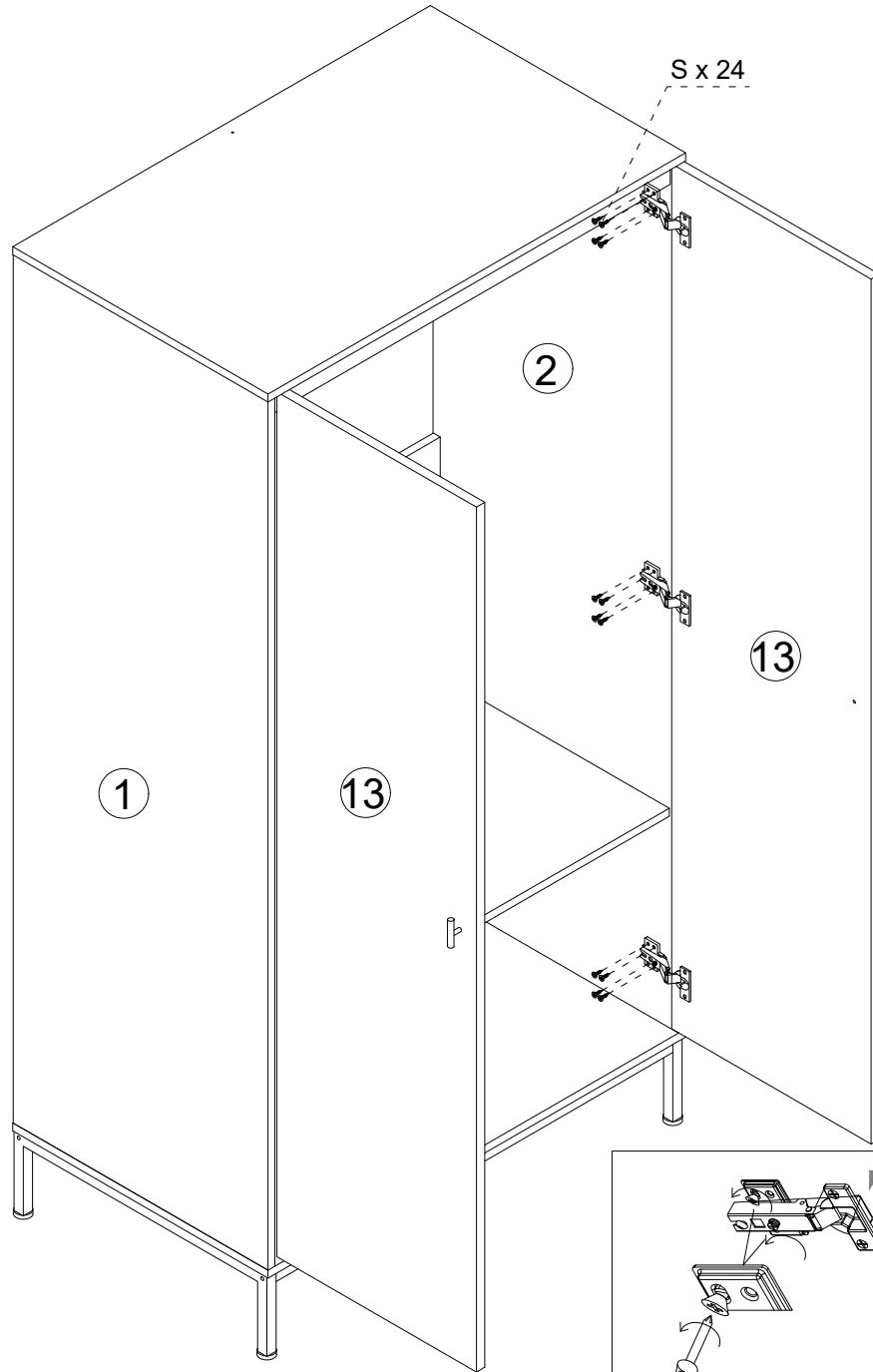

S	
M4*14mm Screw	
24pcs	

12. Attach the plastic buckle to the frame.

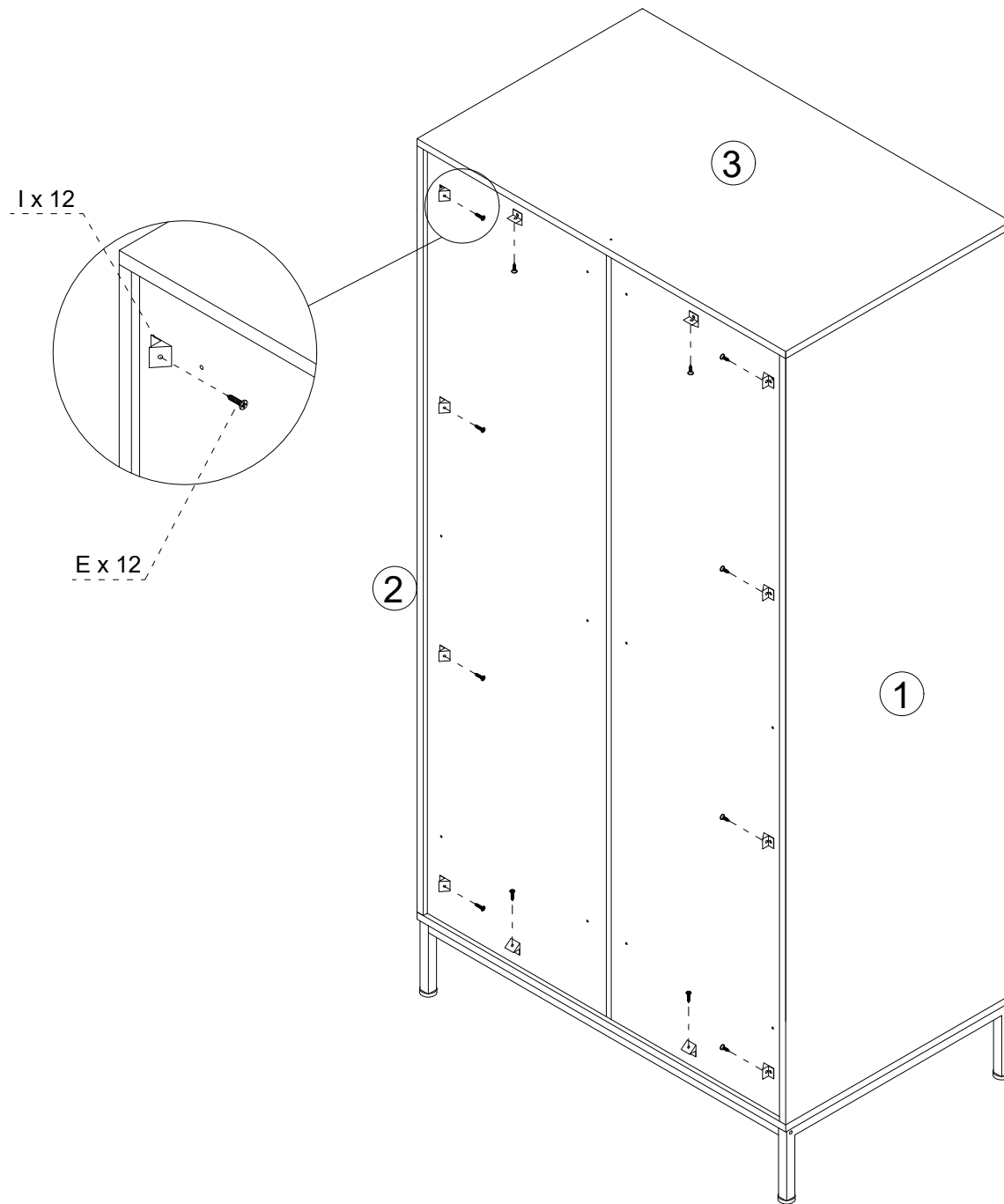

E	
M3*14mm Screw 12pcs	

I	
15x9mm Plastic Buckle 12pcs	

13. Attach parts to the frame.

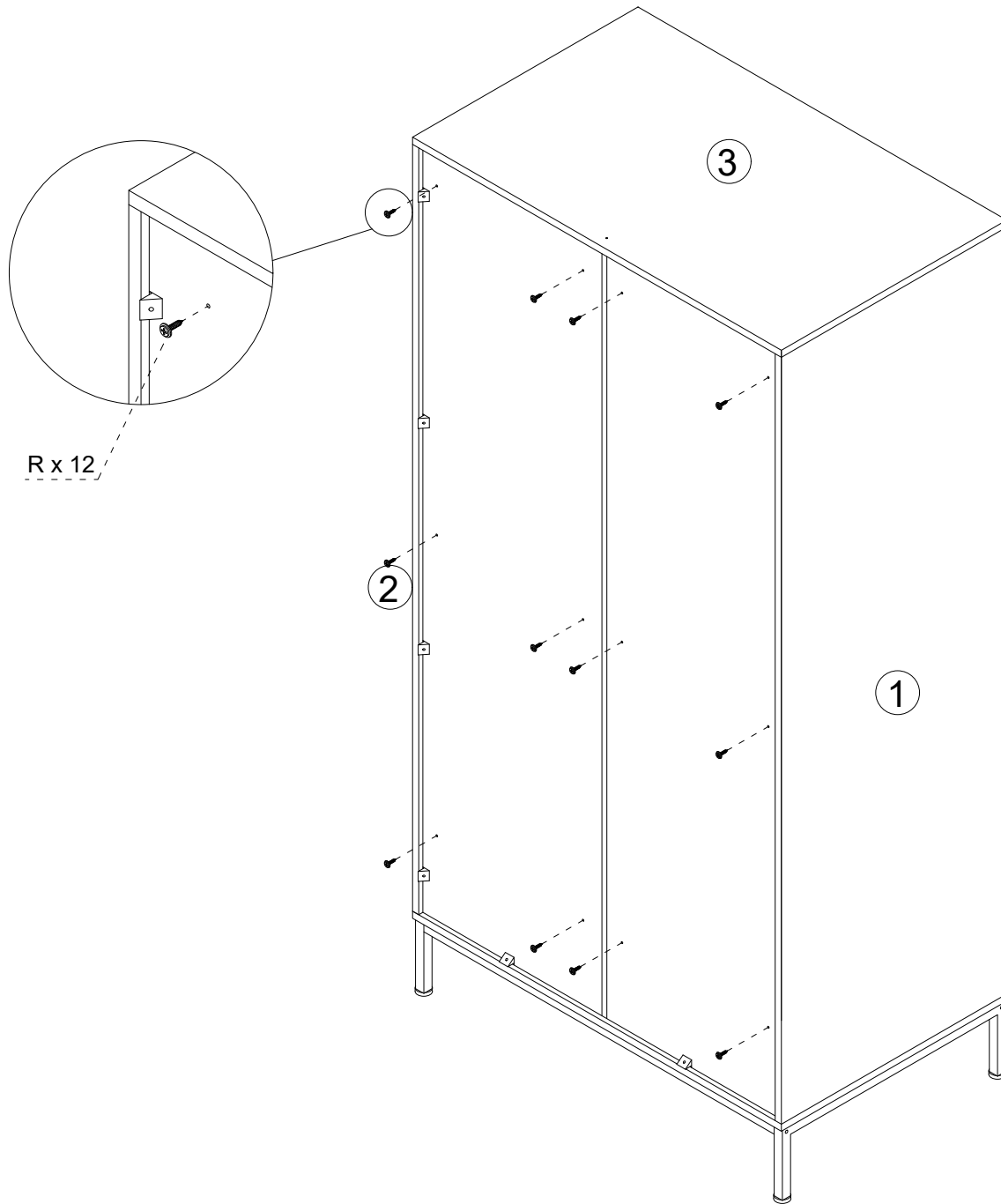

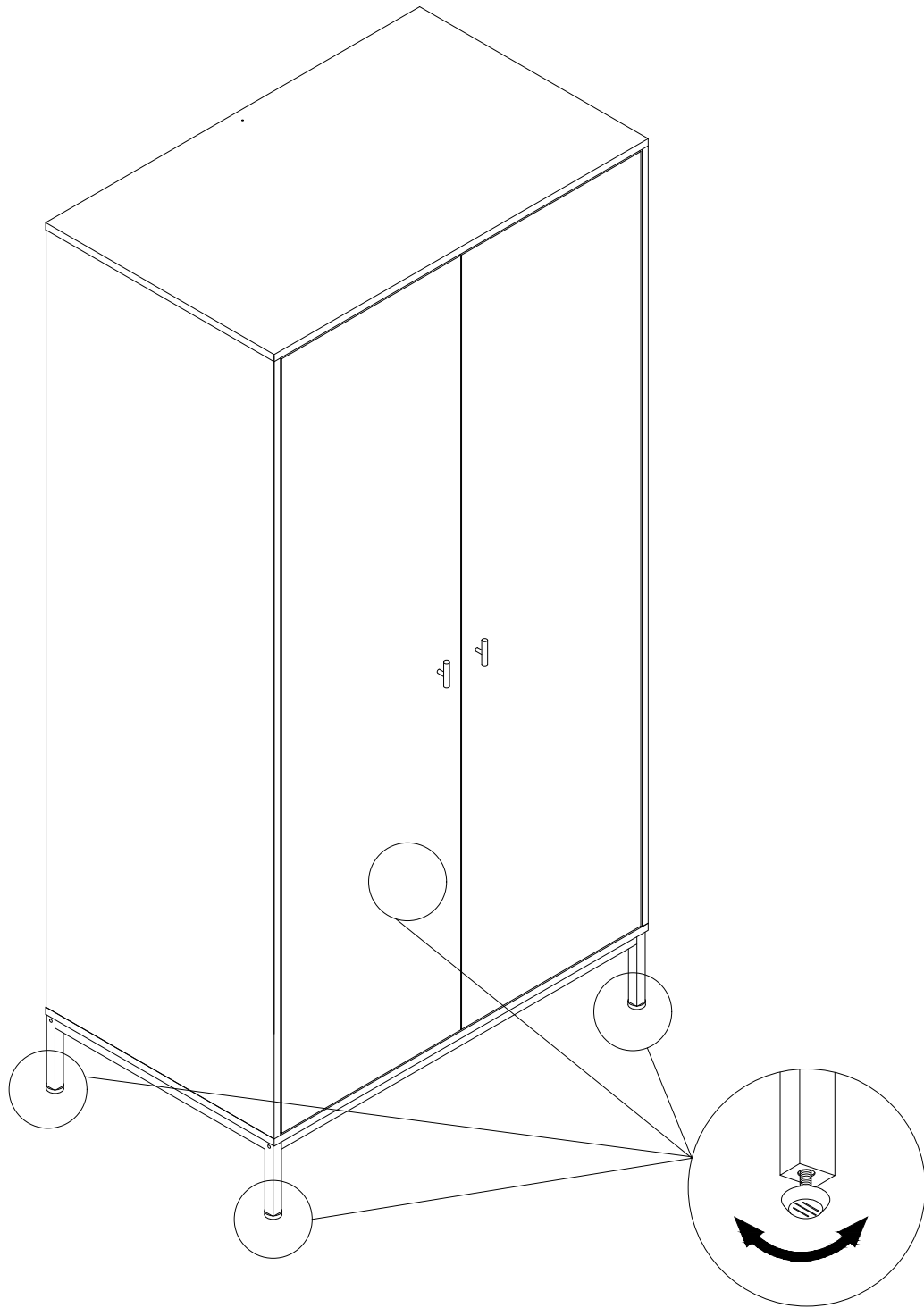

R

M3*14mm Screw
12pcs

14. Adjust the legs.

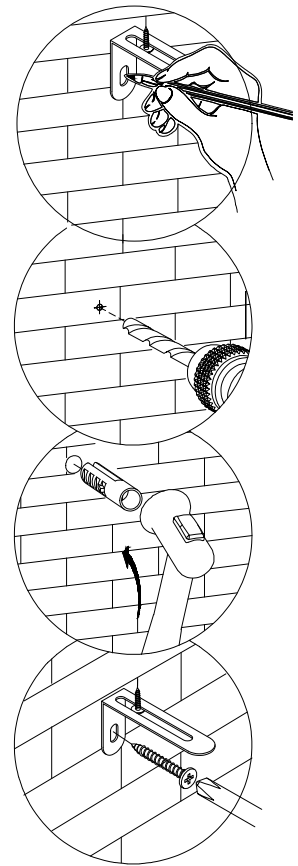
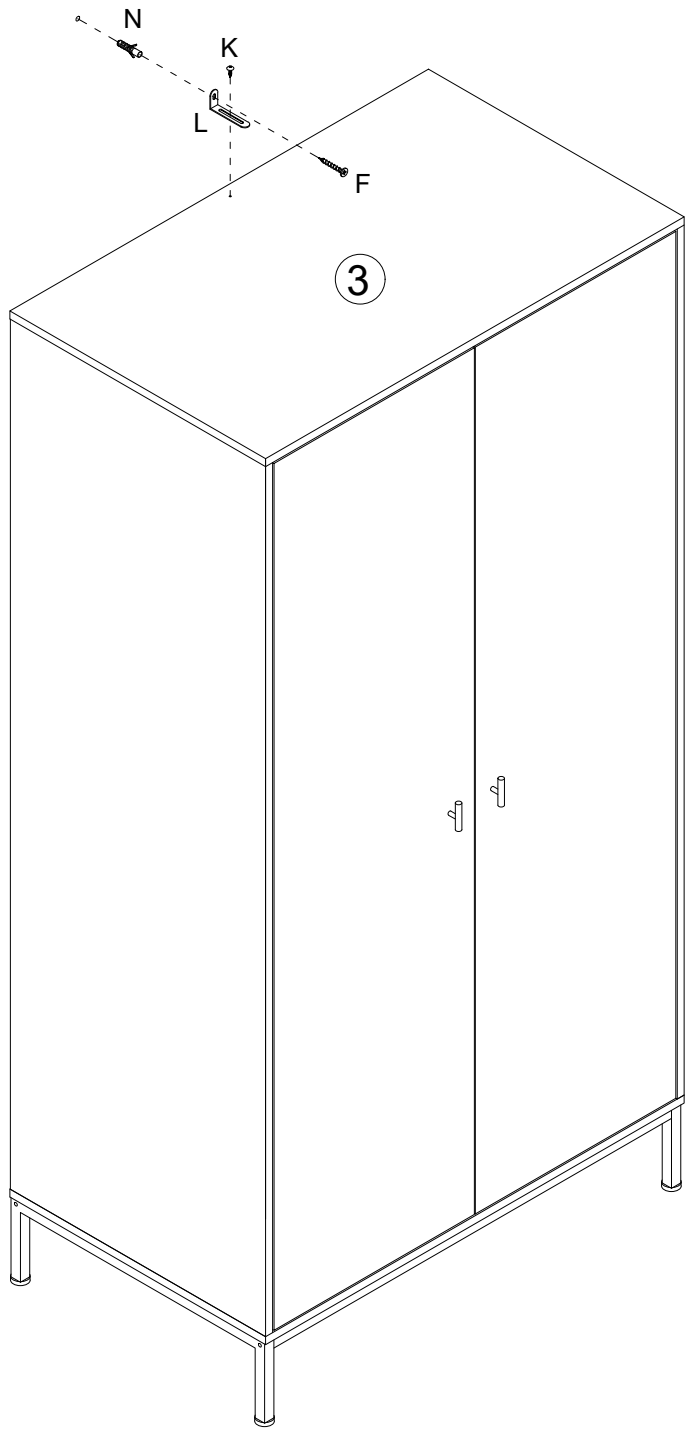



15. Fix the L-shape Bracket to the wall.



F	
M4*35mm Screw	
1pc	

K	
M4*14mm Screw	
1pc	

L	
Wall Bracket	
1pc	

N	
Ø6x30mm Wall Plug	
1pc	