

# PAIR OF SOL CHAIRS INC SEAT CUSHION

ITEM CODE: SOL-01

## Assembly Instructions



Product size:  
W60\*D65\*H84 CM

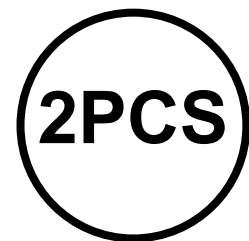

**Furniture should be covered/stored whilst not in use  
to prolong its longevity.**

**(It should also be covered in adverse weather.)**

**This product is for domestic use only.**

**IMPORTANT, PLEASE RETAIN FOR FUTURE REFERENCE  
READ CAREFULLY**

## Before you start



### Warnings

#### IMPORTANT, RETAIN FOR FUTURE REFERENCE READ CAREFULLY

See enclosed instructions for assembly, safety and care information.

Failure to follow the warnings could result in serious injury.

Handle heavy parts with care.

Ensure that this product is fully assembled as illustrated before use.

This product should only be used on firm, level ground.

**The product contains small parts which could pose a risk to young children. Keep small parts out of reach of children.**

Do not stand or climb onto this product.

This product is intended for **domestic use** only.

Ensure the product is always placed on level ground.

Furniture can be dangerous if incorrectly used. No liability will be accepted for damage or injury caused by incorrect use of this product.

Take care when opening and folding furniture. Keep your hands away from moving parts in order to prevent trapping your fingers. Children should not open or close the furniture.

**This table is not intended to support a parasol separately. A parasol base with suitable weight must be used to support your parasol.**



### Dos

When you are ready to start, make sure that you have the right tools, plenty of space and a clean, dry area for assembly.

Unwrap all packaging materials and place the components on suitable surface to prevent scratching your product.

Check the pack and make sure you have all of the parts listed. In the event of problems or missing parts, please contact the seller.

Check all screws and bolts are tightened and inspect regularly.

During severe weather conditions, including high winds, rain, hail, thunderstorms, extreme heat and cold temperatures, the product should be stored inside in a cool, dry place.

To best preserve this product, please use a protective cover when your furniture is not in use. We would also recommend using a gazebo or parasol over your furniture during the summer period and prolonged sunny spells. This will help prevent harmful UV rays from damaging and discolouring the material.

Timber is a natural product and contains coloured resins which may initially bleed out of the timber when its gets wet. Therefore we recommend that care is taken to protect patios and decking from possible staining where the product comes into contact with the ground. The furniture will stabilise in its environment after the first few times it gets wet.

Wood is a natural material whose appearance will deteriorate when left outside. A surface coating is vital in protecting it from premature darkening, or splitting, when exposed to the weather. The finish should be regularly maintained to ensure that the wood is protected from moisture and the furniture continues to look at its best.

This product has been treated with furniture oil during manufacture and the wood requires further treatment before being left out side. When applying furniture oil particular care should be given to the end grain and any joints or crevices, please note that is the products needs to be put together the first coat should be applied to all wood surfaces before assembly.

Should you choose not to treat your furniture, then it will turn a greyish colour and develop cracks. Light sanding can restore the original colour after which furniture oil can be regularly applied in accordance with the instructions above.

A liberal coating of furniture oil should be given to the furniture before it is laid up, and again when it is removed from storage.

Clean your product with a sponge and warm soapy water then wipe with a clean, dry cloth.

Ensure that the product is clean and dry before storage.

Where instructions as to the; storage, commissioning, installation, use and maintenance of the goods or (if there is none) good trade practice are not followed and a defect arises this will void the 12 month manufacturer's guarantee on the product.

### X Don'ts

Do not use scourers, abrasives, washing powders, chemical cleaners or any other substances containing abrasives since these substances can damage the product.

To preserve the product do not place greasy / oily items directly onto the wooden surface.

Do not place very hot or very cold items on the wooden surface unless adequately thick place-mats are used to prevent such items from coming into contact with the wood.

Do not strike the product with hard or pointed items.

Do not sit or lean on the arms of this product.

Do not use power tools to construct this product.

Do not tighten screws until fully assembled.

Do not overtighten screws or bolts.

Do not use this product if parts are missing, damaged or worn.

Do not place furniture near the outdoor exhaust vents.

Do not write on furniture without a padded barrier to protect the surface.

Do not stand or climb onto the product and do not use it as a ladder, as this could lead to it unbalancing and overturning.

Never tilt the product during use.

Never drag furniture when moving it, always lift it.

The One-Seater product is intended for max use 120 kgs, 2-Seater product is intended for max use 200 kgs, 3-Seater product is intended for max use 250 kgs, do not exceed this weight.

### Number of people required for assembly

Two people



### Time to assemble

30 Minutes

### Tools required





(Not provided)

# PAIR OF SOL CHAIRS INC SEAT CUSHION

ITEM CODE: SOL-01

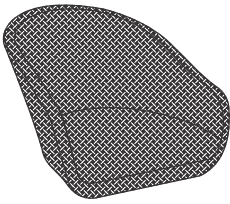
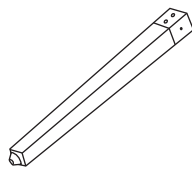
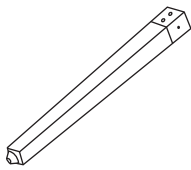
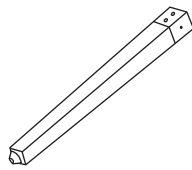
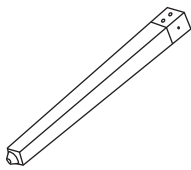
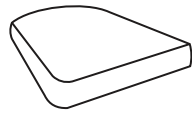
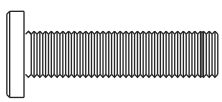
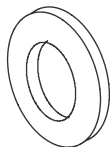
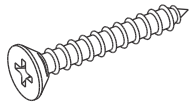
Components, fixtures & fittings (not actual size)

Parts List					
Part No.	Diagram	Qty.	Part No.	Diagram	Qty.
A	 Seat	2 PCS	B	 Front Left Leg	2 PCS
C	 Front Right Leg	2 PCS	D	 Rear Left Leg	2 PCS
E	 Rear Right Leg	2 PCS	F	 Seat Cushion	2 PCS
B25	 Bolt M6*25mm	16 PCS	W	 Washer	16 PCS
ST25	 Self-Taping Screw M4*25mm	8 PCS	AK	 Allen Key	1 PC



# PAIR OF SOL CHAIRS INC SEAT CUSHION

ITEM CODE: SOL-01

## Step by step assembly instructions

### Step One

With the help of another person, attach the Front Left Leg (B), Front Right Leg (C), Rear Left Leg (D) and Rear Right Leg (E) to the Seat (A) using Washers(W), Bolts (B25) and Self-Taping Screws (ST25).

Tighten All Bolts and Screws reasonably. Do not over-tighten.

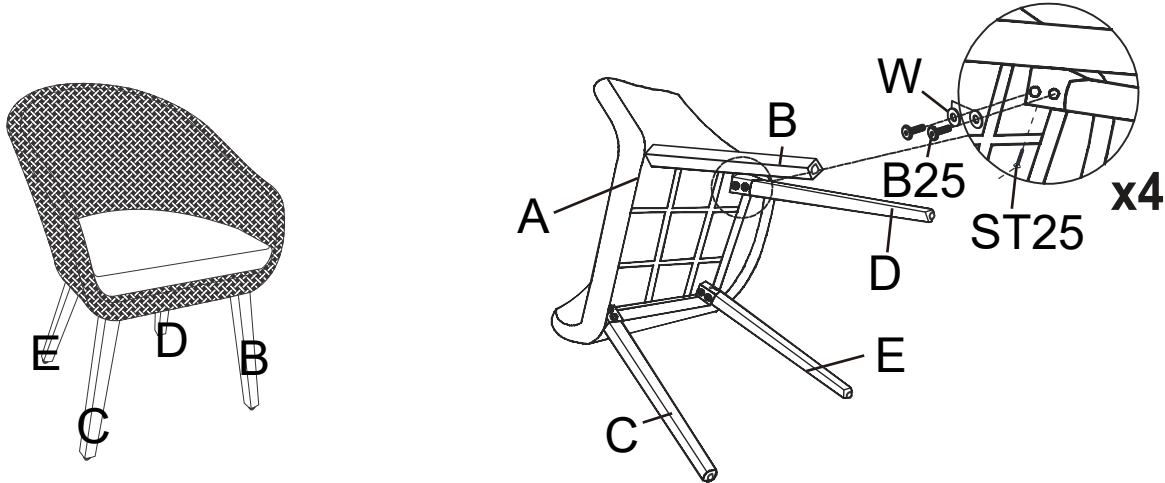

### Step Two

Stand the Chair, level the Chair with Adjustable Feet Screws under the legs. Place the Seat Cushion (F) to the Seat.

Your Chair is now ready for use.

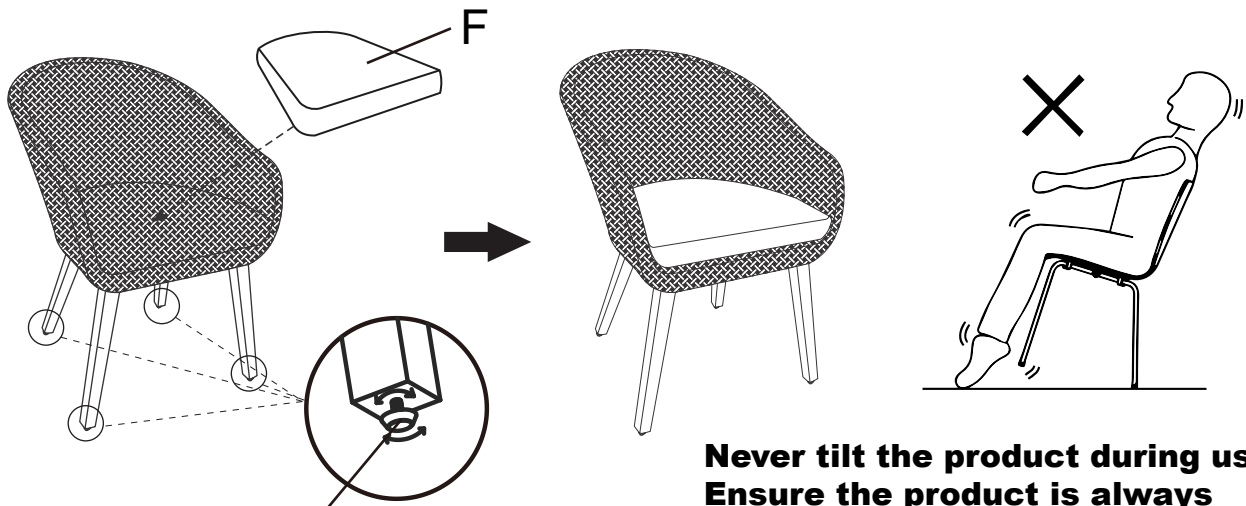

Adjustable Feet Screws

**Never tilt the product during use.  
Ensure the product is always  
placed firmly on the ground.**

**PLEASE KEEP THESE INSTRUCTIONS FOR FUTURE REFERENCE**

[www.royalcraft.co.uk](http://www.royalcraft.co.uk)