

**DUSK.COM**  
LIVING | BEDROOM | DINING

Range Name : NELL  
Box dimensions : 188x43.5x21cm  
Range Name : POPPY  
Box dimensions : 86.5x43.5x11.5cm  
188x44x18cm  
Range Name : POPPY & NELL  
Box dimensions : 86.5x43.5x11.5cm  
188x44x18cm

## Nell / Poppy / Poppy & Nell Hallway Shelf with Cupboard

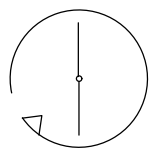
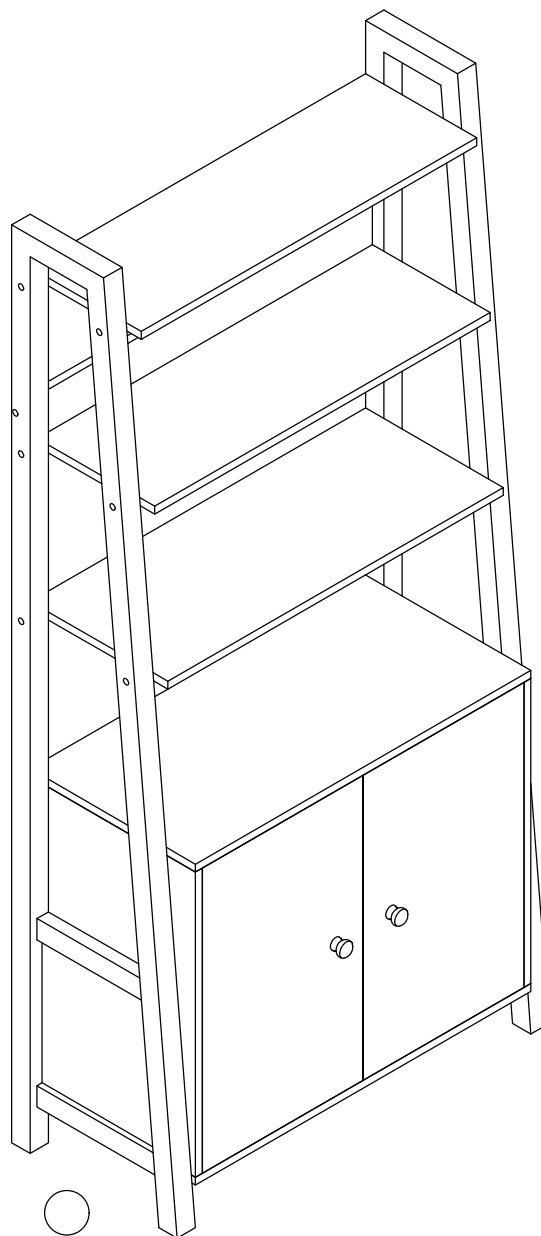

Up to 30 minutes  
assembly time

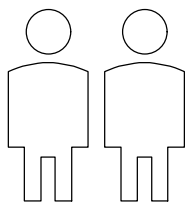

Two person  
assembly

This product is intended for domestic use only, not for commercial purposes.

## IMPORTANT

### ASSEMBLY TIP

Before you begin, it's best to identify all of the parts and fittings to build your Evie Large Chest frame. We advise laying these out on the floor to check you have everything, and to familiarise yourself with all of the parts and fittings before building.

### TOP TIP

We recommend that you assemble the Evie Large Chest in the room you'd like it to be located. This will help prevent any risk of damage to the frame whilst moving it.

### SAFETY AND CARE

It's important to ensure children and animals are kept away from the assembly area, as there are small components used in this product which could present a choking hazard. All plastic and wrapping materials should also be kept away from children and animals to prevent any risk of suffocation.

### HELP AND SUPPORT

Please contact our customer service team on 0113 519 0311 if you have any questions or issues with your purchase.

### RECYCLING

Please ensure that packaging is disposed of in a safe and environmentally friendly way, and recycle where possible. Please keep your assembly instructions safe to refer back to in the future.

### CARE AND MAINTENANCE:

1. Only clean using a damp cloth, do not use bleach or abrasive cleaners as they may damage the finish over time.
2. Do not use a very wet cloth or allow any liquid to contact with the veneer for a long period of time. Wipe any spillage immediately. Absorption can cause wood to warp or finishes to de-laminate.
3. Do not scrub or rub the surface when cleaning.
4. Do not drag the Evie Large Chest when moving, lift it off the floor instead.
5. Use a placemat or a coaster when putting hot items (e.g. hot drinks and dishes) on the wood surface.
6. It is not recommended to place the item next to sources of heat such as radiators, fires or directly exposed to sunlight. This may cause the wood to crack, split or fade due to the heat and humidity.
7. Wood will mellow and change colour over time, we recommend that ornaments and items placed on the surface to be moved regularly to prevent uneven mellowing.
8. Regularly check all fixings to ensure none have come loose. Re-tighten if necessary.
9. Avoid sharp items such as a screwdriver or any pointy tools.
10. Dispose of all packaging carefully and responsibly - recycle where possible.

# Parts list



Before you begin building your Willow Bedside, please take a moment to read through the instructions and make sure that you have all the relevant parts listed on the parts check list.

Part Number	Part Description	Quantity
①	Left Side Frame	1pc
②	Right Side Frame	1pc
③	Top	1pc
④	Middle Panel	1pc
⑤	Middle Panel	1pc
⑥	Middle Panel	1pc
⑦	Middle Panel	1pc
⑧	Bottom Panel	1pc
⑨	Top Back Support Strip	1pc
⑩	Left Side Panel	1pc
⑪	Right Side Panel	1pc

Part Number	Part Description	Quantity
⑫	Door Front	2pcs
⑬	Up Back Panel	1pc
⑭	Down Back Panel	1pc

# Fittings

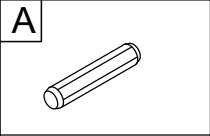
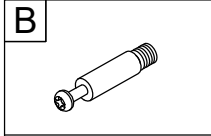
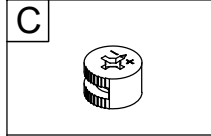
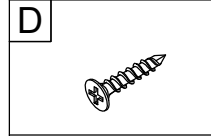
Please check you have all the fittings listed below with your product.

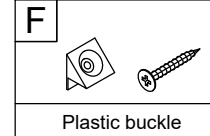
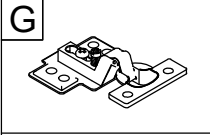
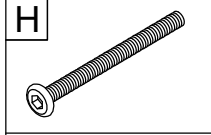
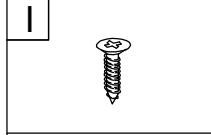
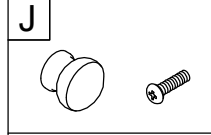
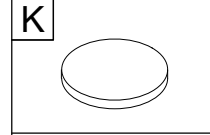
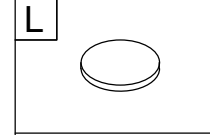
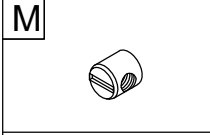
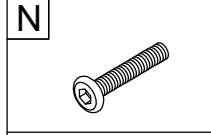
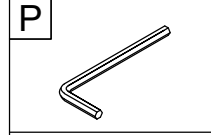
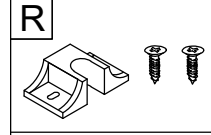
 <p>Ø6x30mm Dowel 24pcs+3pcs extra</p>	 <p>M6*35mm Bolt 14pcs+1pc extra</p>	 <p>Ø15x9.5mm Cam Lock 14pcs+1pc extra</p>	 <p>M4*35mm Screw 7pcs</p>	 <p>Anti-fall rope Gasket M4*14mm Screw 2sets</p>	 <p>Plastic buckle M3*16mm Screw 4sets</p>
 <p>Hinge 4pcs</p>	 <p>M6*70mm Screw 14pcs+1pc extra</p>	 <p>M3.5*14mm Screw 24pcs+3pcs extra</p>	 <p>Handle M4*16mm Screw 2sets</p>	 <p>Foot Gasket 4pcs</p>	 <p>Hole Gasket 53pcs+6pcs extra</p>
 <p>Vertical Nut 14pcs+1pc extra</p>	 <p>M6*25mm Screw 8pcs+1pc extra</p>	 <p>Ø4mm Allen key 1pc</p>	 <p>Door Stop M3*12mm Screw 1set</p>		

# Parts list

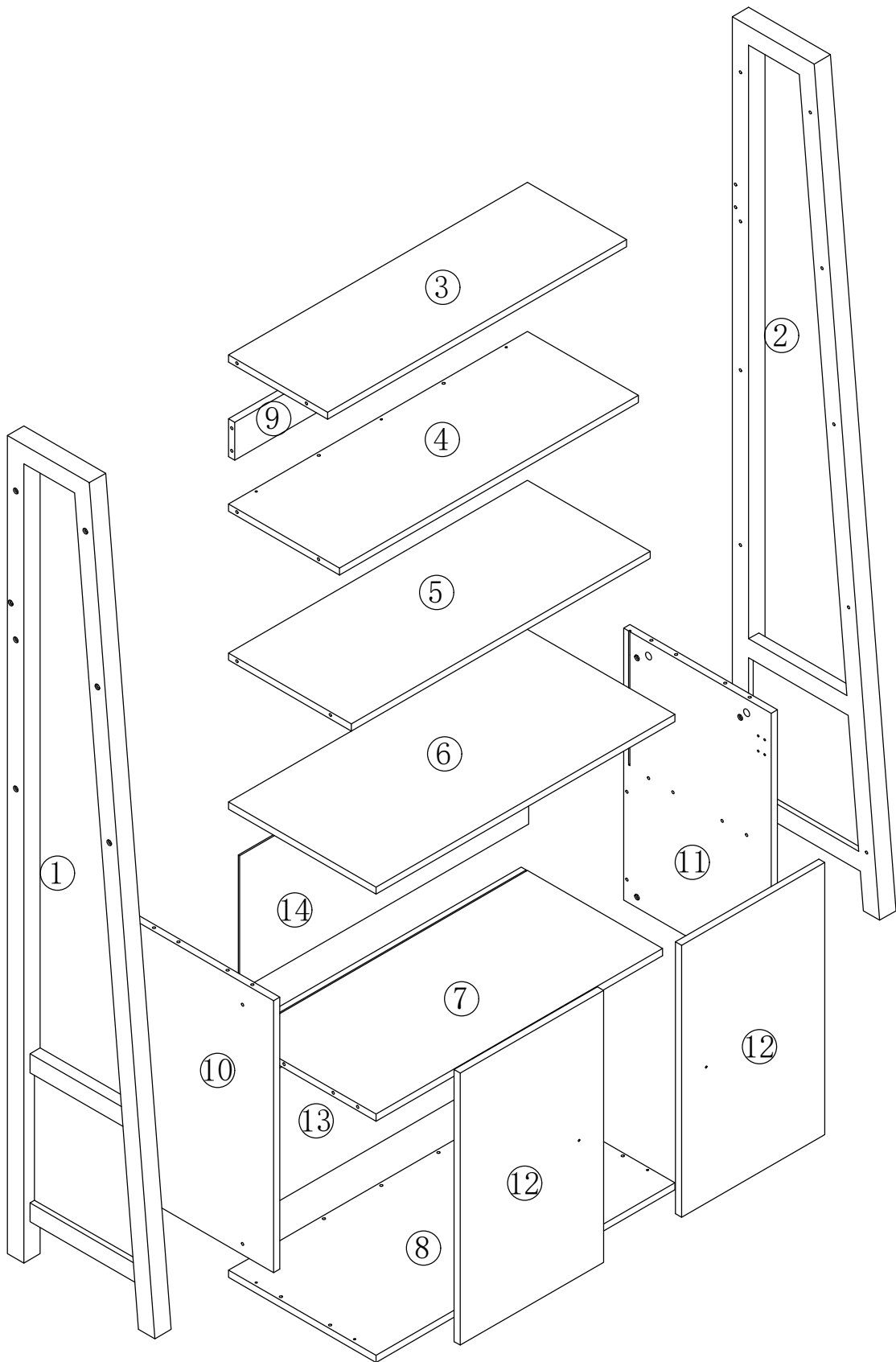

# 1.Attach parts to the panels.

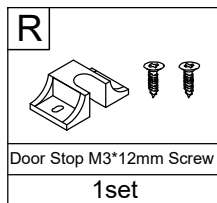
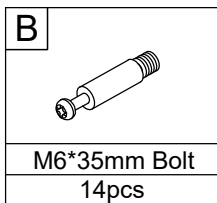
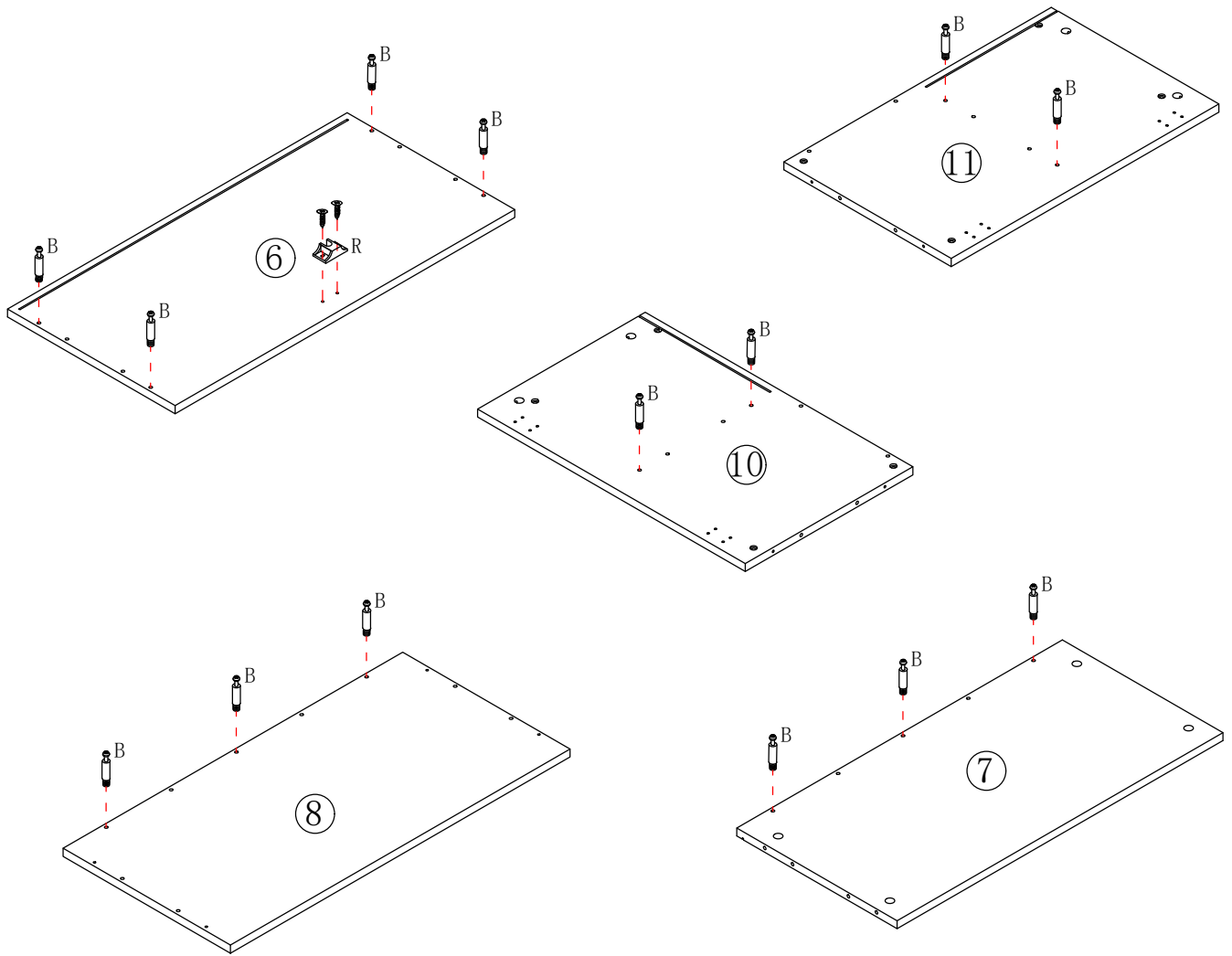

# 2.Attach top back support strip to the middle panel.

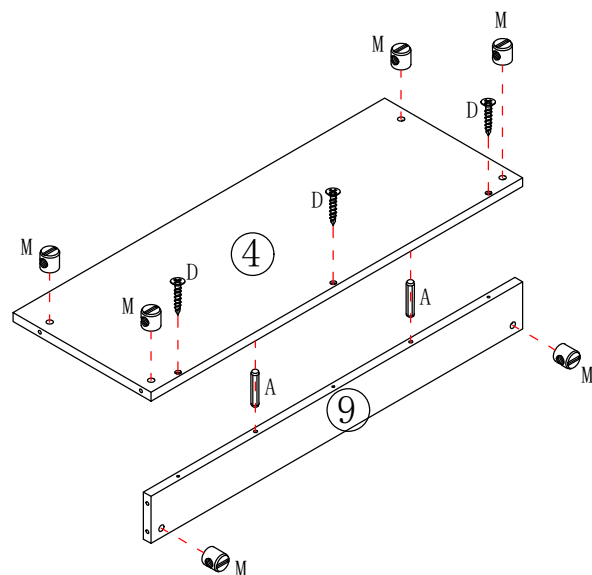
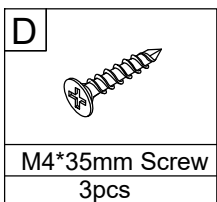
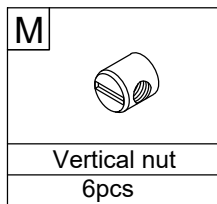
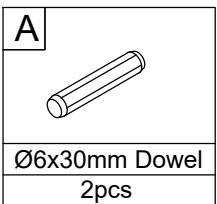

### 3. Attach back panel to the middle panel.

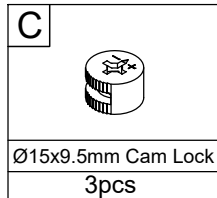
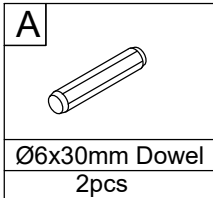
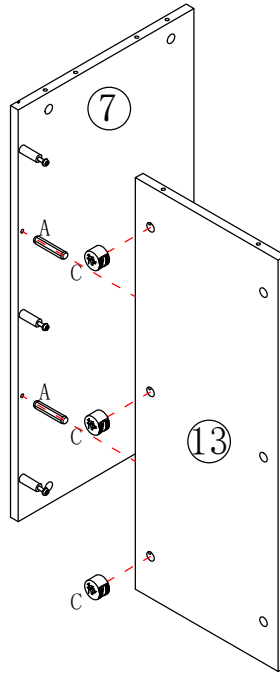

### 4. Attach panel to the left side panel.

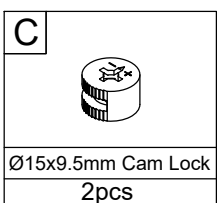
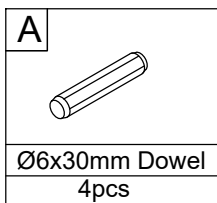
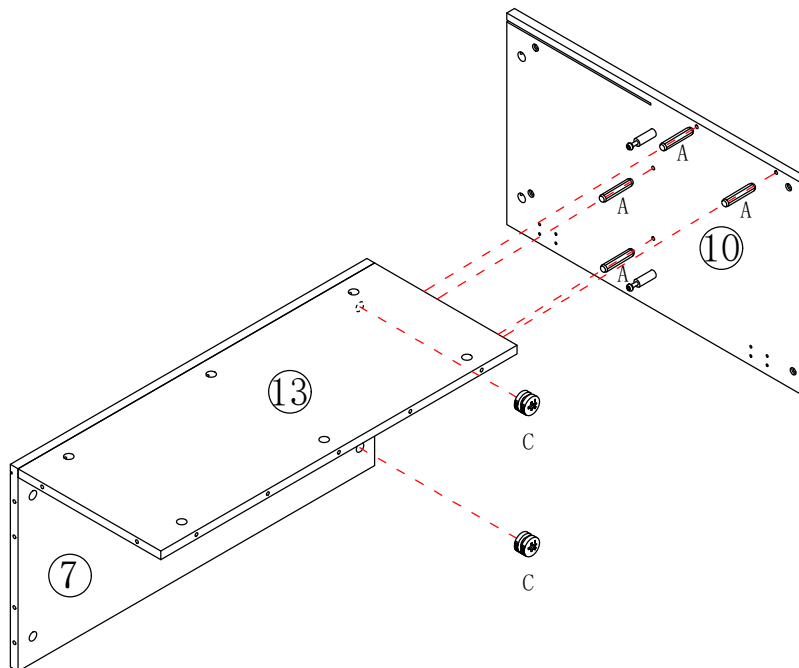

## 5. Assemble right side panel.

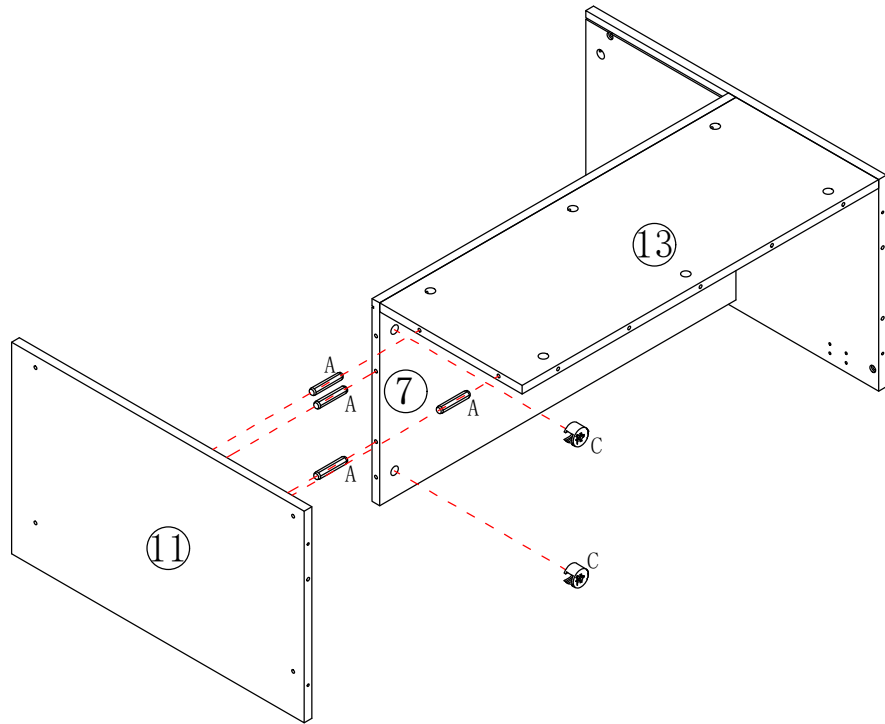
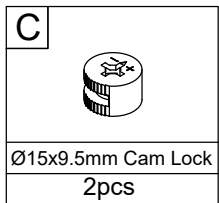
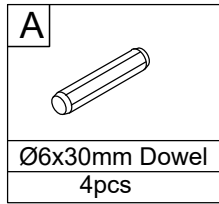

## 6. Attach bottom panel to the frame.

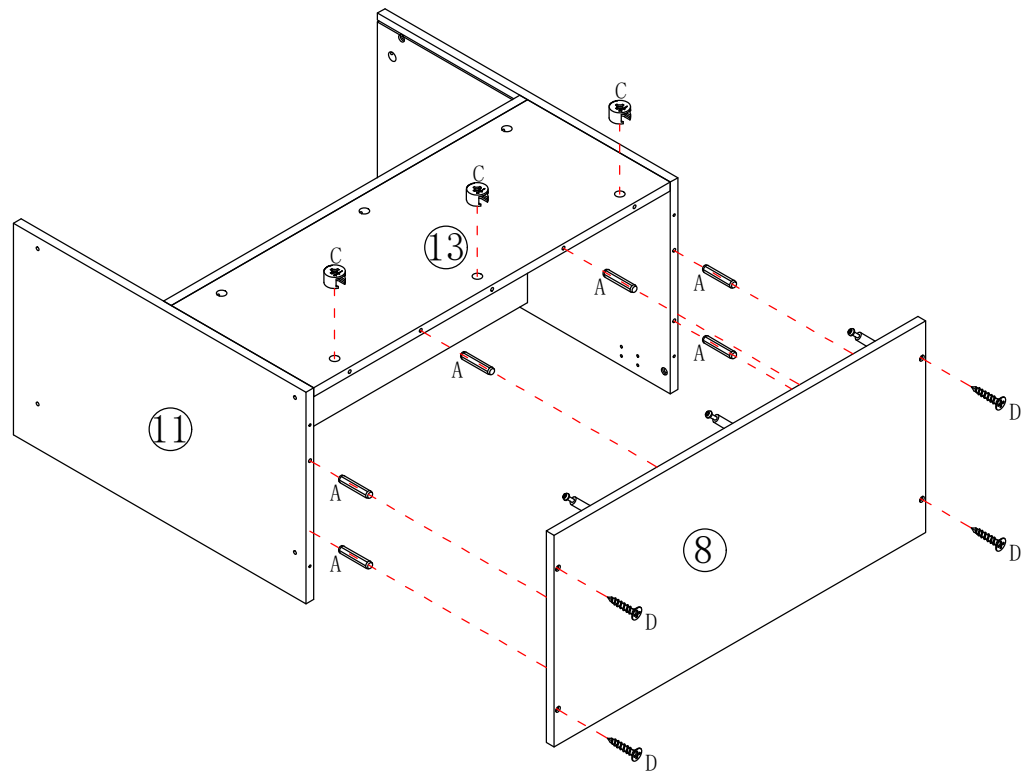
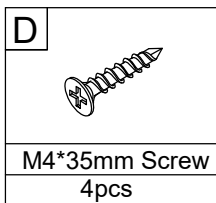
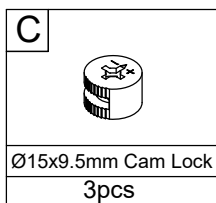
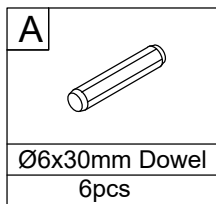

## 7. Assemble back panel.

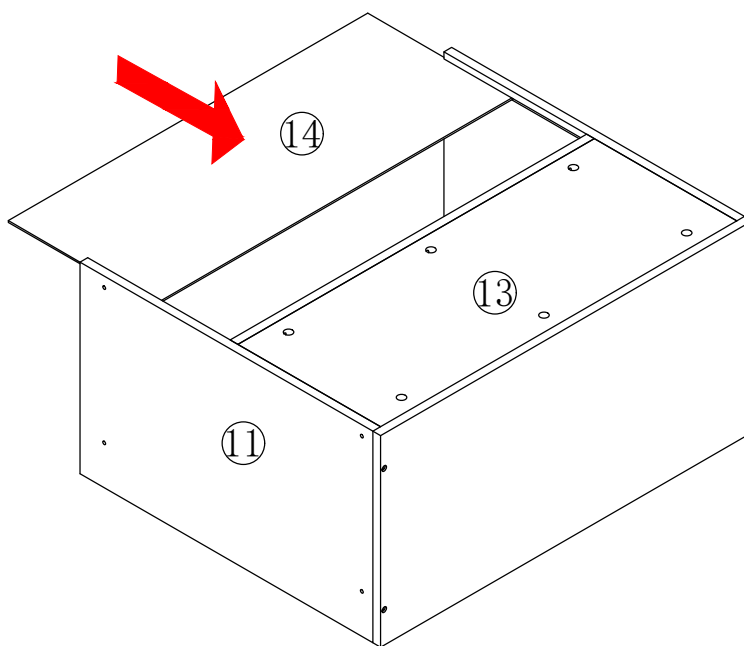

## 8. Attach middle panel to the frame.

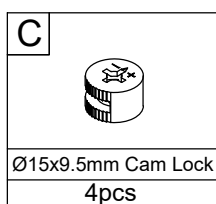
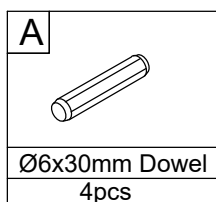
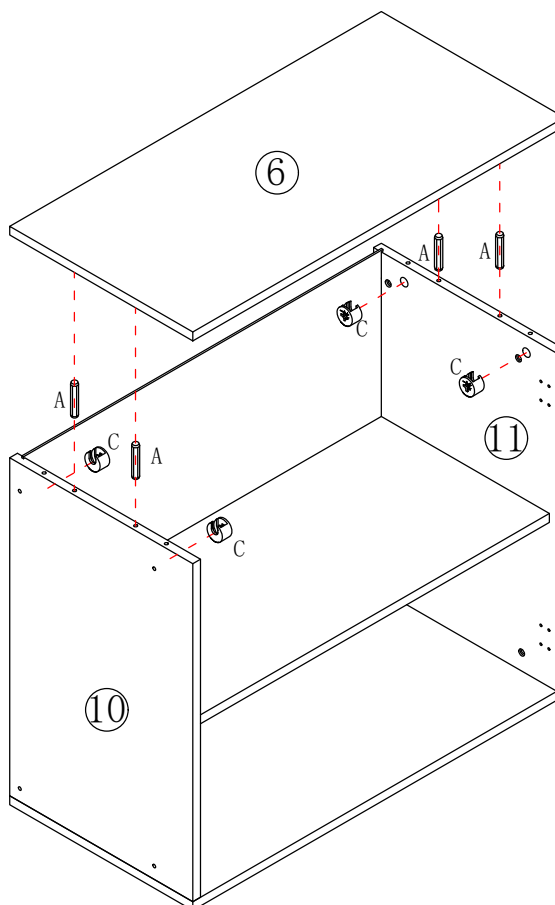



## 9. Attach vertical nuts to the panel and attach parts to the right side frame.

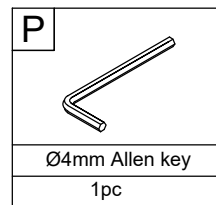
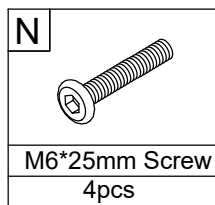
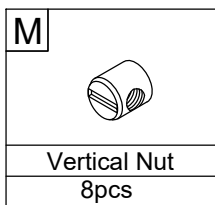
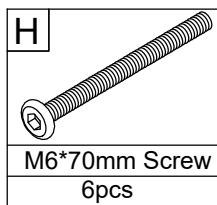
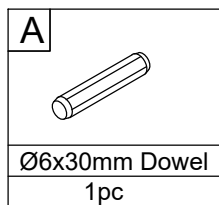
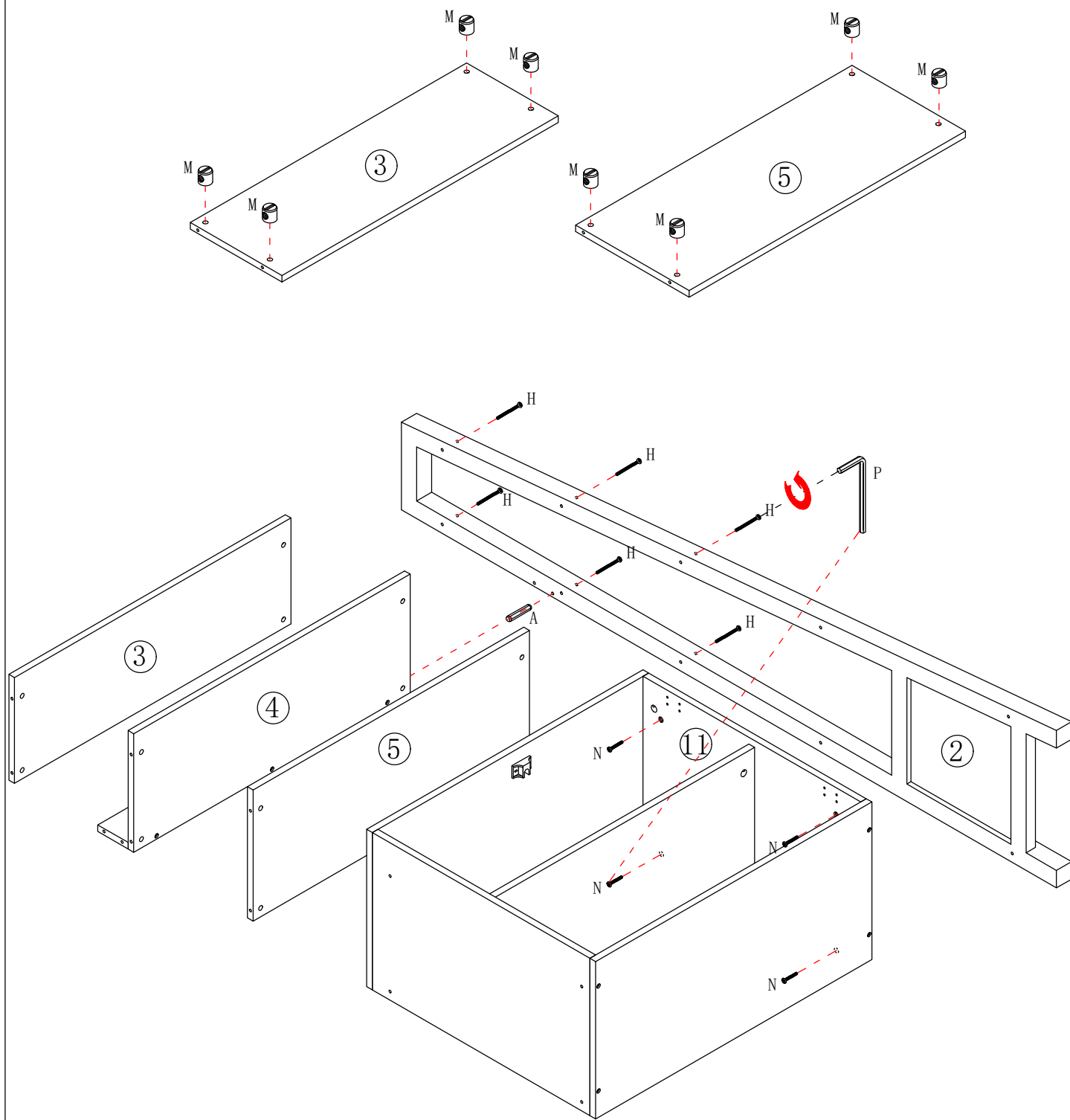

## 10. Assemble left side frame.

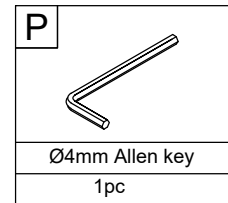
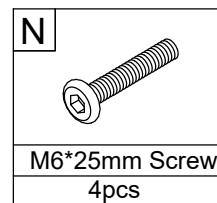
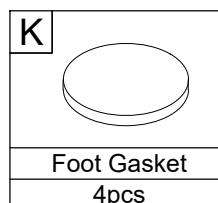
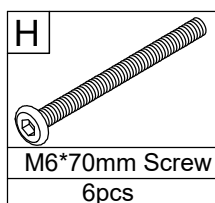
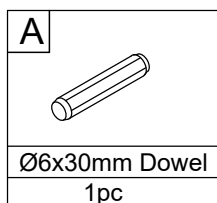
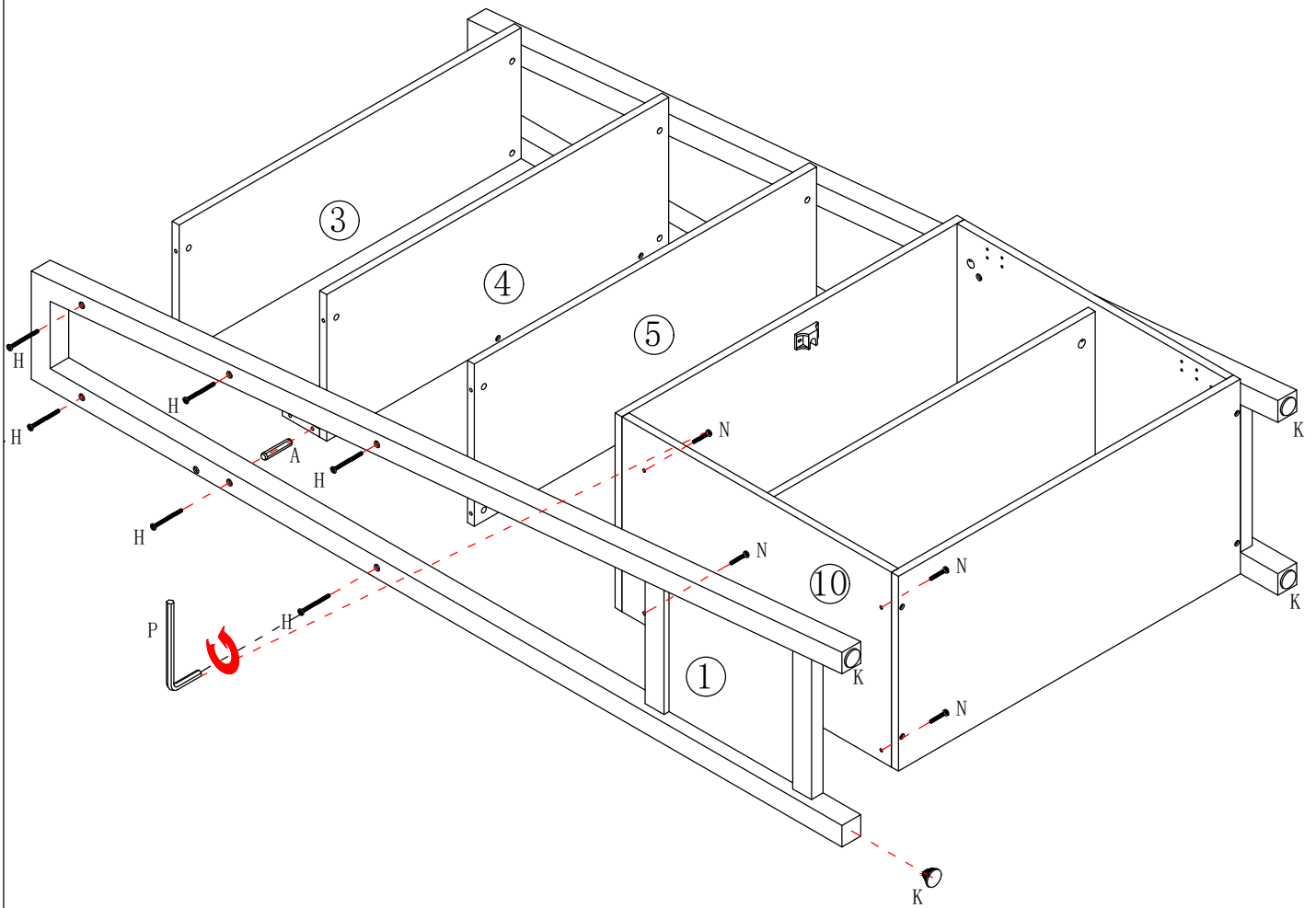

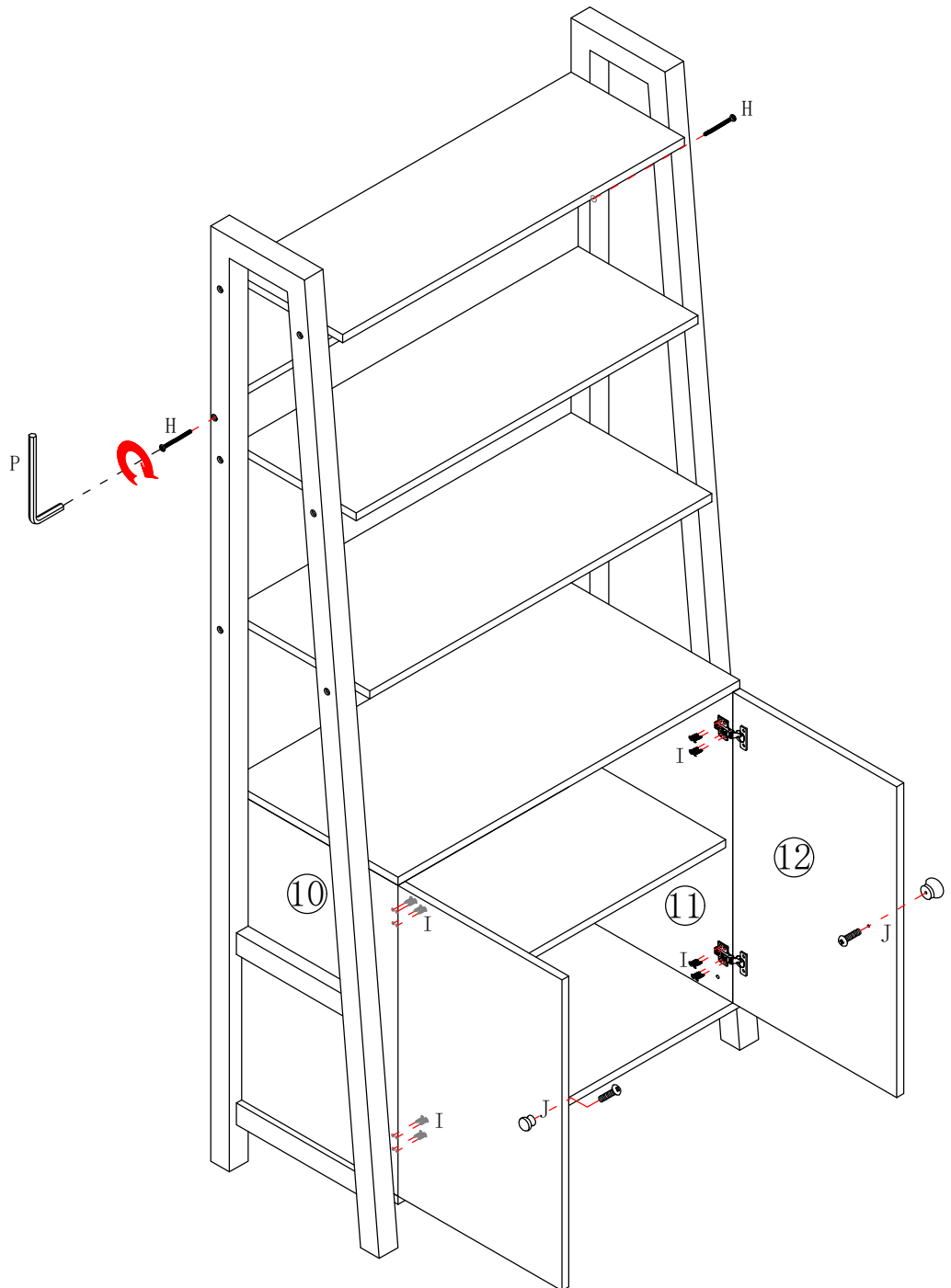
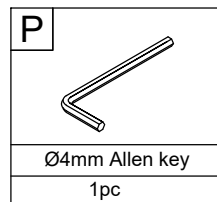
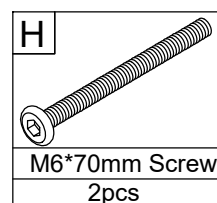
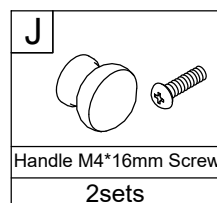
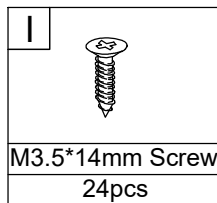
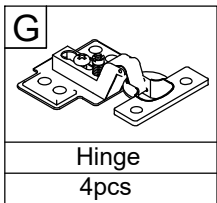
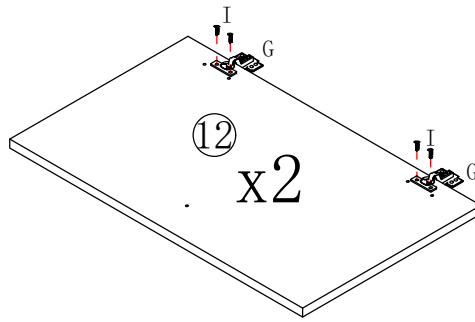

# 11. Attach door to the frame

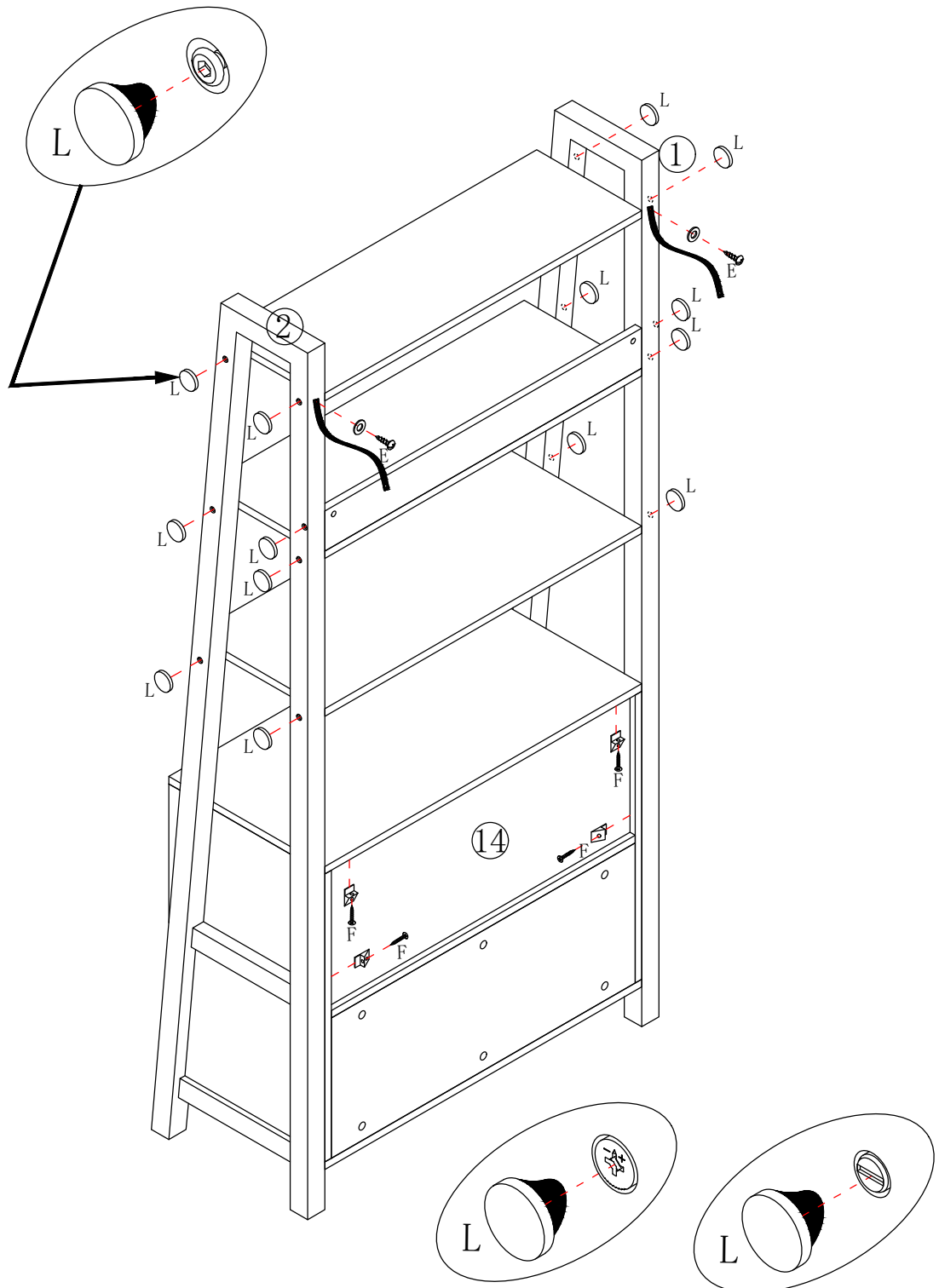

## 12. Assemble the plastic buckles, anti-fall rope and gaske to the frame.



<b>E</b>	
Anti-fall rope Gasket M4*14mm Screw	
2sets	

<b>F</b>	
Plastic buckle M3*16mm Screw	
4sets	

<b>L</b>	
Hole Gasket	
53pcs	

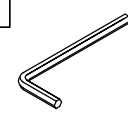
<b>P</b>	
Ø4mm Allen key	
1pc	

**WARNING:** Please make the choice of screws according to your own wall for wall locking. In order to prevent overturning this product must be used with the wall attachment device provided.

