

Lila Dining Table

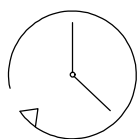

Up to 20 minutes
assembly time

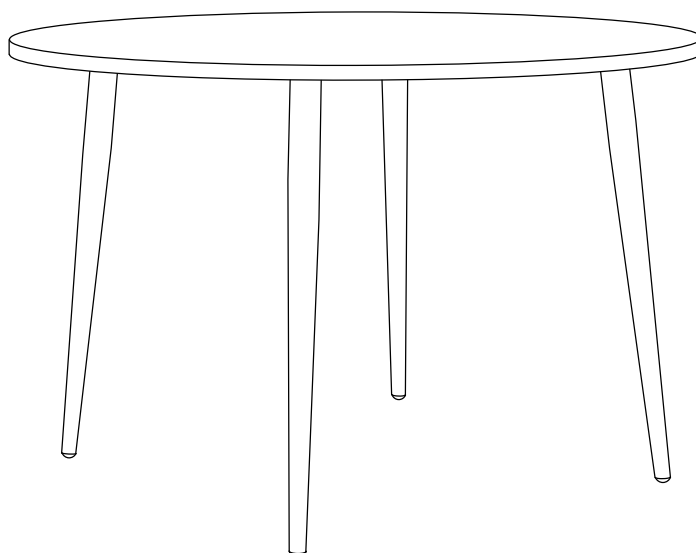
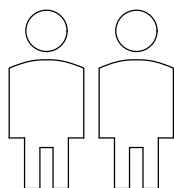

Two person
assembly

This product is intended for domestic use only, not commercial purposes.

IMPORTANT

ASSEMBLY TIP

Before you begin, it's best to identify all of the parts and fittings to build your table frame. We advise laying these out on the clean and flat floor to check you have everything, and to familiarise yourself with all of the parts and fittings before building.

TOP TIP

We recommend that you assemble the table in the room you'd like it to be located. This will help prevent any risk of damage to the frame whilst moving it.

SAFETY AND CARE

1. Do not stand on your product. Pregnant women should take additional care when using this product. Do not leave the child unattended. Children should always be under direct adult supervision whilst using this product. Always use on firm level ground, ensuring all legs remain in contact with the ground.
2. It's important to ensure children and animals are kept away from the assembly area, as there are small components used in this product which could present a choking hazard. All plastic and wrapping materials should also be kept away from children and animals to prevent any risk of suffocation.

HELP AND SUPPORT

Please contact our customer service team on 0113 519 0311 if you have any questions or issues with your purchase.

RECYCLING

Please ensure that packaging is disposed of in a safe and environmentally friendly way, and recycle where possible. Please keep your assembly instructions safe to refer back to in the future.

CARE AND MAINTENANCE:

1. Only use clean, colourless sponge or cloth to avoid any colour transfer or smearing, do not use bleach or abrasive cleaners as they may damage the marble top over time.
2. Do not use a very wet cloth or allow any liquid to contact with the marble for a long period of time. Wipe any spillage immediately.
3. Do not scrub or rub the surface when cleaning.
4. Do not drag the table when moving, lift it off the floor instead.
5. Use a placemat or a coaster when putting hot items (e.g. hot drinks and dishes) on the marble surface.
6. It is not recommended to place the item next to sources of heat such as radiators, fires or directly exposed to sunlight.
7. Regularly check all fixings to ensure none have come loose. Re-tighten if necessary.
8. Avoid sharp items such as a screwdriver or any pointy tools.
9. Dispose of all packaging carefully and responsibly - recycle where possible.
10. Due to the delicate nature of this product, please gently place hard items onto the table top to avoid damaging the surface.

Parts list

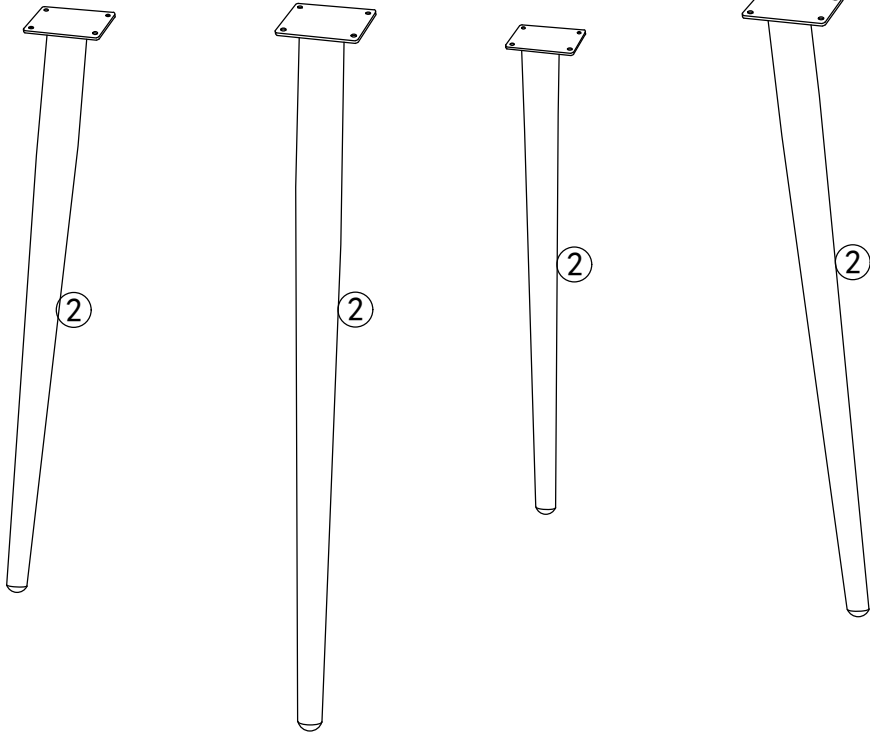
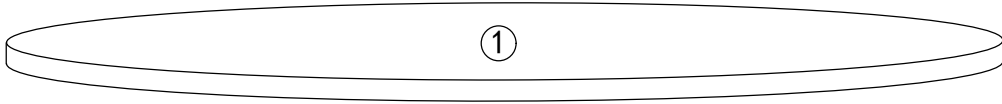



Parts list

Before you begin building your Lila dining table, please take a moment to read through the instructions and make sure that you have all the relevant parts listed on the parts check list.

Part Number	Part Description	Quantity	Box NO
①	Table Top	1 pc	Box 1
②	Leg	4 pcs	Box 2



Fittings

Please check you have all the fittings listed below with your product in Box 1.

A	B	C
		
4mm Allen Key	M6*16mm Bolt	M6*Ø16mm Flat Washer
1 pc	16pcs+1pc extra	16pcs+1pc extra

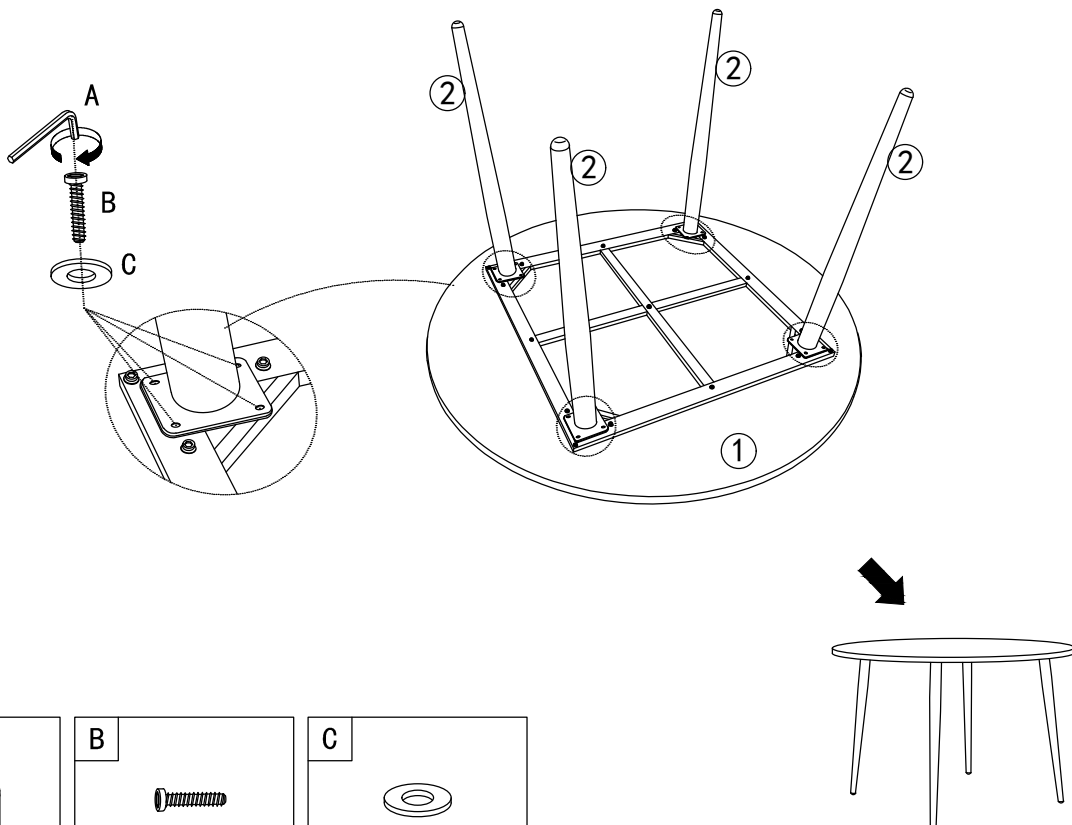
1. Attaching the legs to the table top.



A	B	C
		
4mm Allen Key	M6*16mm Bolt	M6*Ø16mm Flat Washer
1 pc	16pcs+1pc extra	16pcs+1pc extra