

DUSK.COM

LIVING | BEDROOM | DINING

Range Name : Talia

Box1 Dimension : W89xD46xH89cm

Product Dimension : W80xD40xH80cm

Coffee Table

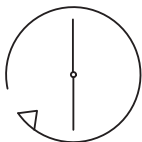
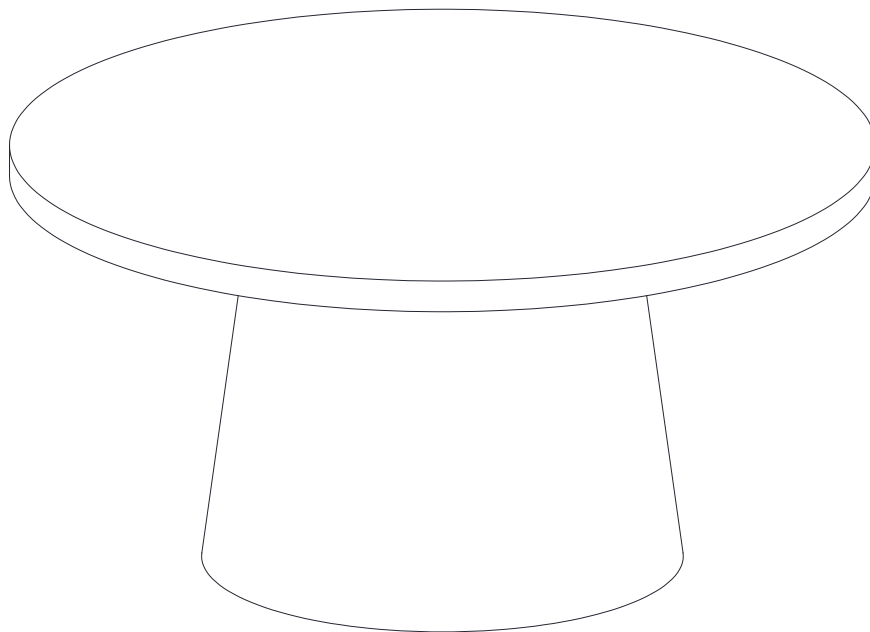

Up to 30 minutes
assembly time

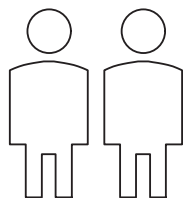

Two person
assembly



Electric screwdriver
prohibited

This product is intended for domestic use only, not for commercial purposes.

P-1-7
V-1.0

IMPORTANT

ASSEMBLY TIP

Before you begin, it's best to identify all of the parts and fittings to build your Talia Coffee Table frame. We advise laying these out on the floor to check you have everything, and to familiarise yourself with all of the parts and fittings before building.

TOP TIP

We recommend that you assemble the Talia Coffee Table in the room you'd like it to be located. This will help prevent any risk of damage to the frame whilst moving it.

SAFETY AND CARE

It's important to ensure children and animals are kept away from the assembly area, as there are small components used in this product which could present a choking hazard. All plastic and wrapping materials should also be kept away from children and animals to prevent any risk of suffocation.

HELP AND SUPPORT

Please contact our customer service team on 0113 519 0311 if you have any questions or issues with your purchase.

RECYCLING

Please ensure that packaging is disposed of in a safe and environmentally friendly way, and recycle where possible. Please keep your assembly instructions safe to refer back to in the future.

CARE AND MAINTENANCE:

1. Only clean using a damp cloth, do not use bleach or abrasive cleaners as they may damage the finish over time.
2. Do not use a very wet cloth or allow any liquid to contact with the veneer for a long period of time. Wipe any spillage immediately. Absorption can cause wood to warp or finishes to de-laminate.
3. Do not scrub or rub the surface when cleaning.
4. Do not drag the Talia Coffee Table when moving, lift it off the floor instead.
5. Use a placemat or a coaster when putting hot items (e.g. hot drinks and dishes) on the wood surface.
6. It is not recommended to place the item next to sources of heat such as radiators, fires or directly exposed to sunlight. This may cause the wood to crack, split or fade due to the heat and humidity.
7. Wood will mellow and change colour over time, we recommend that ornaments and items placed on the surface to be moved regularly to prevent uneven mellowing.
8. Regularly check all fixings to ensure none have come loose. Re-tighten if necessary.
9. Avoid sharp items such as a screwdriver or any pointy tools.
10. Dispose of all packaging carefully and responsibly - recycle where possible.

Parts list

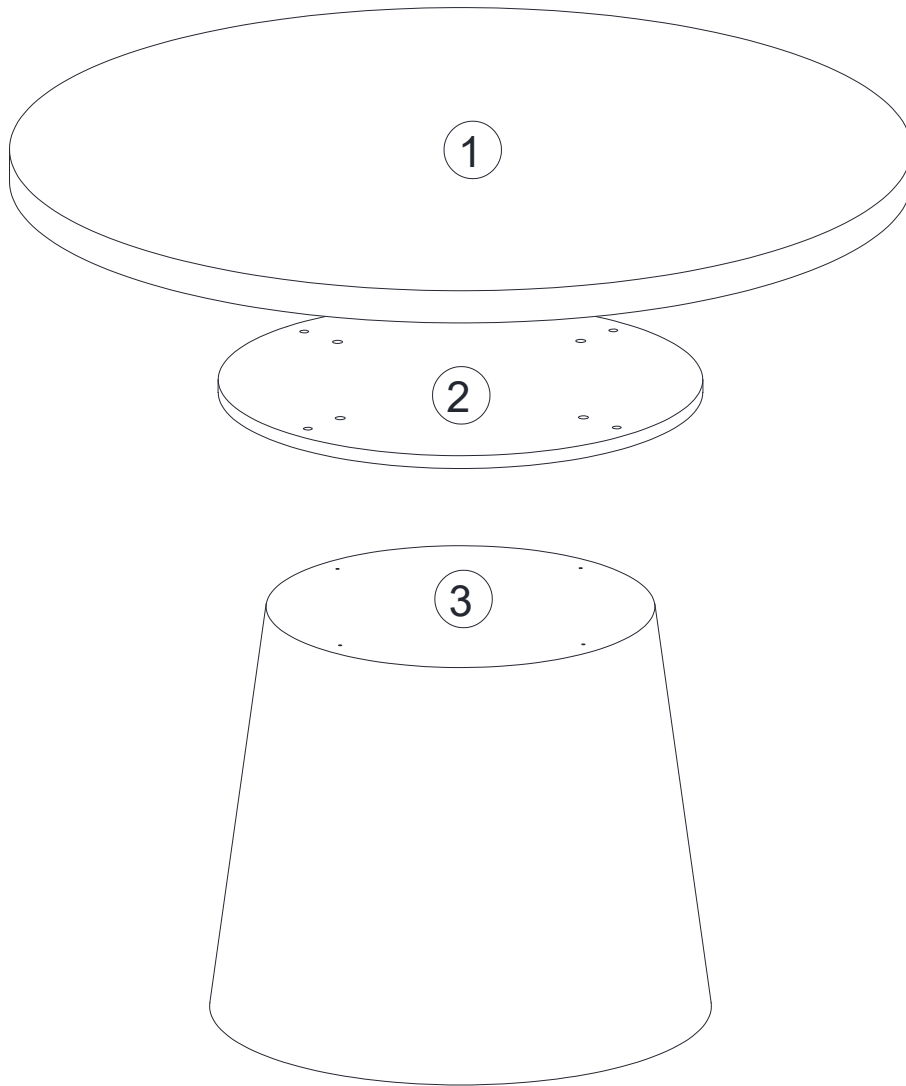





Parts list

Before you begin building your Talia Coffee Table, please take a moment to read through the instructions and make sure that you have all the relevant parts listed on the parts check list.

Part Number	Part Description	Quantity	Box No
①	Top Panel	1pc	Box 1
②	Connecting Panel	1pc	Box 1
③	Bottom Base	1pc	Box 1

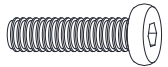
Fittings

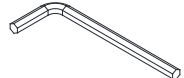
Please check you have all the fittings listed below with your product in box 1.



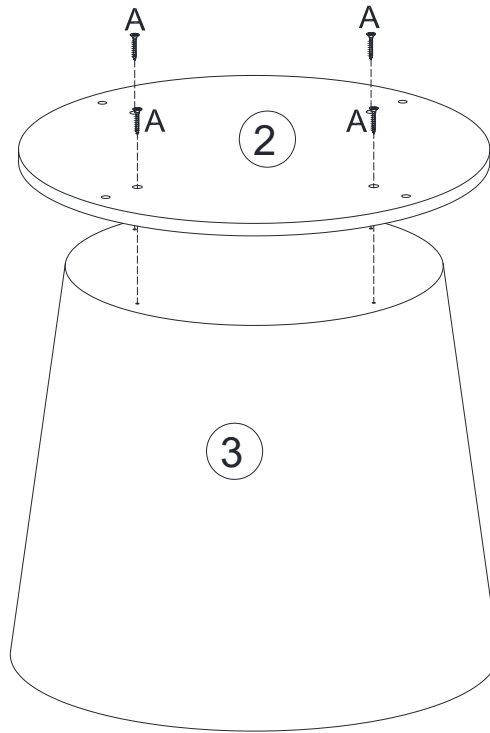

A  M4*35mm Screw 4pcs	B  M6*25mm Screw 4pcs	C  Gasket 4pcs	D  Allen Key 1pcs	E  Pad 6pcs
--	--	---	---	--

1. Attach parts to the boards.

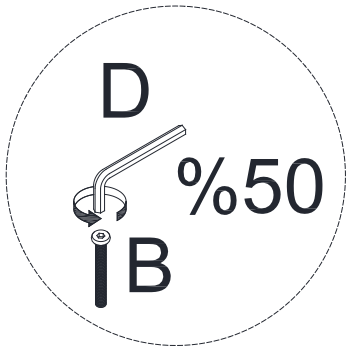
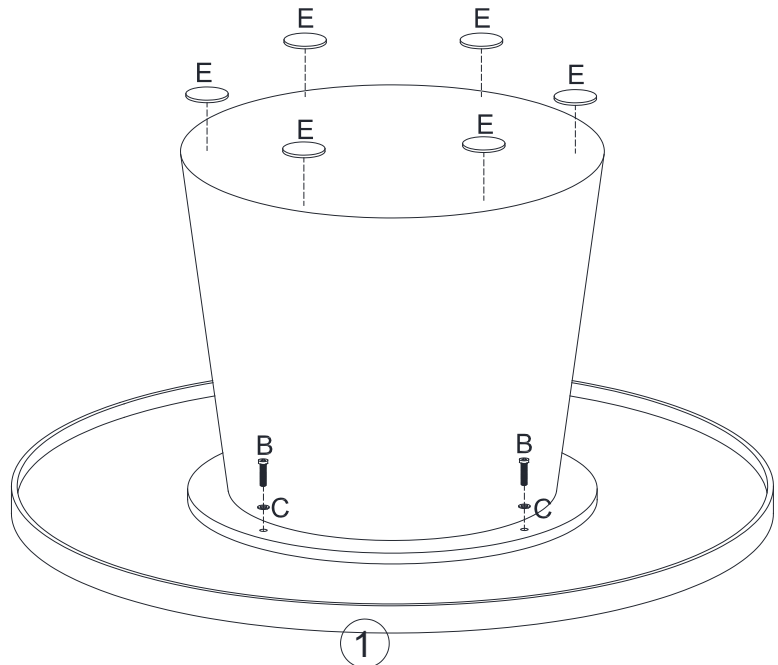

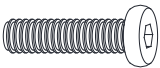
A

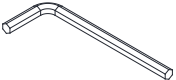
M4*35mm Screw 4pcs

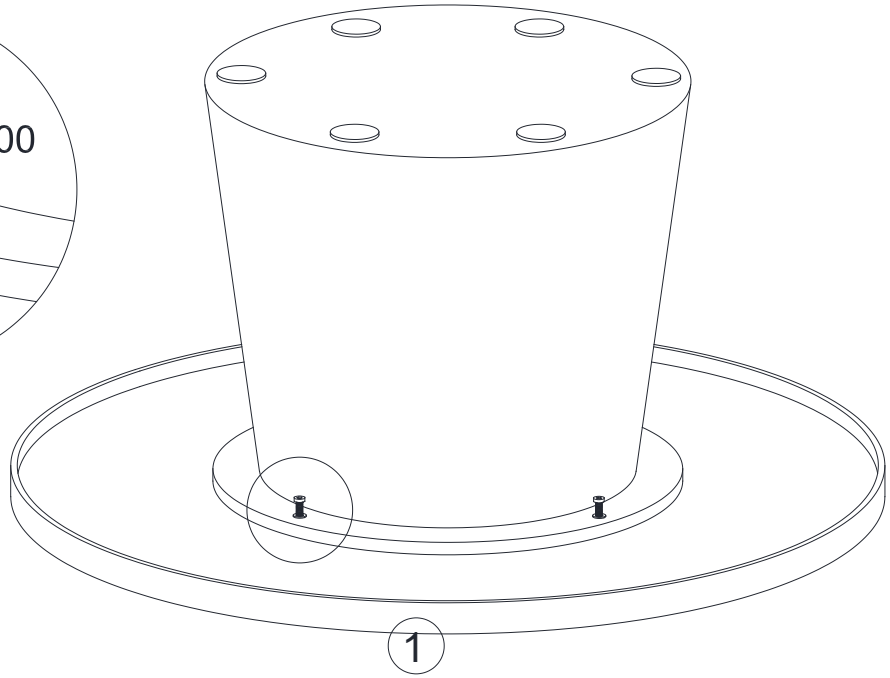
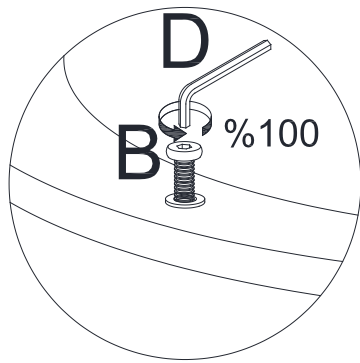

B	C	D	E
			
M6*25mm Screw 4pcs	Gasket 4pcs	Allen Key 1pc	Pad 6pcs

3. Attach parts to the boards.



4.

