

DUSK.COM

LIVING | BEDROOM | DINING

Range Name : Rachel

Box1 Dimension : W185.5xD64.5xH19cm

Box2Dimension :W185.5xD66xH14.5cm

Product Dimension : W125xD95xH180cm

3 Door Wardrobe

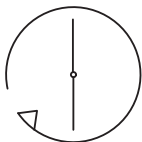
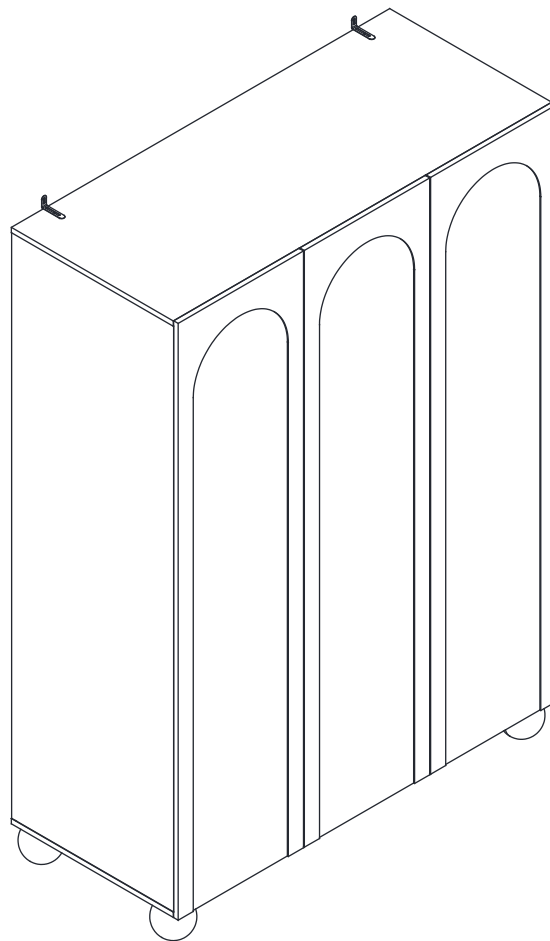

Up to 120 minute
sassembly time

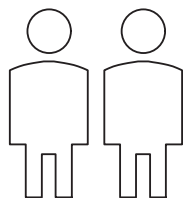

Two person
assembly



Electric screwdriver
prohibited

This product is intended for domestic use only,not for commercial purposes.

P-1-14
V-1.0

IMPORTANT

ASSEMBLY TIP

Before you begin, it's best to identify all of the parts and fittings to build your Rachel 3 door wardrobe frame. We advise laying these out on the floor to check you have everything, and to familiarise yourself with all of the parts and fittings before building.

TOP TIP

We recommend that you assemble the Rachel 3 door wardrobe in the room you'd like it to be located. This will help prevent any risk of damage to the frame whilst moving it.

SAFETY AND CARE

It's important to ensure children and animals are kept away from the assembly area, as there are small components used in this product which could present a choking hazard. All plastic and wrapping materials should also be kept away from children and animals to prevent any risk of suffocation.

HELP AND SUPPORT

Please contact our customer service team on 0113 519 0311 if you have any questions or issues with your purchase.

RECYCLING

Please ensure that packaging is disposed of in a safe and environmentally friendly way, and recycle where possible. Please keep your assembly instructions safe to refer back to in the future.

CARE AND MAINTENANCE:

1. Only clean using a damp cloth, do not use bleach or abrasive cleaners as they may damage the finish over time.
2. Do not use a very wet cloth or allow any liquid to contact with the veneer for a long period of time. Wipe any spillage immediately. Absorption can cause wood to warp or finishes to de-laminate.
3. Do not scrub or rub the surface when cleaning.
4. Do not drag the Rachel 3 door wardrobe when moving, lift it off the floor instead.
5. Use a placemat or a coaster when putting hot items (e.g. hot drinks and dishes) on the wood surface.
6. It is not recommended to place the item next to sources of heat such as radiators, fires or directly exposed to sunlight. This may cause the wood to crack, split or fade due to the heat and humidity.
7. Wood will mellow and change colour over time, we recommend that ornaments and items placed on the surface to be moved regularly to prevent uneven mellowing.
8. Regularly check all fixings to ensure none have come loose. Re-tighten if necessary.
9. Avoid sharp items such as a screwdriver or any pointy tools.
10. Dispose of all packaging carefully and responsibly - recycle where possible.

Parts list

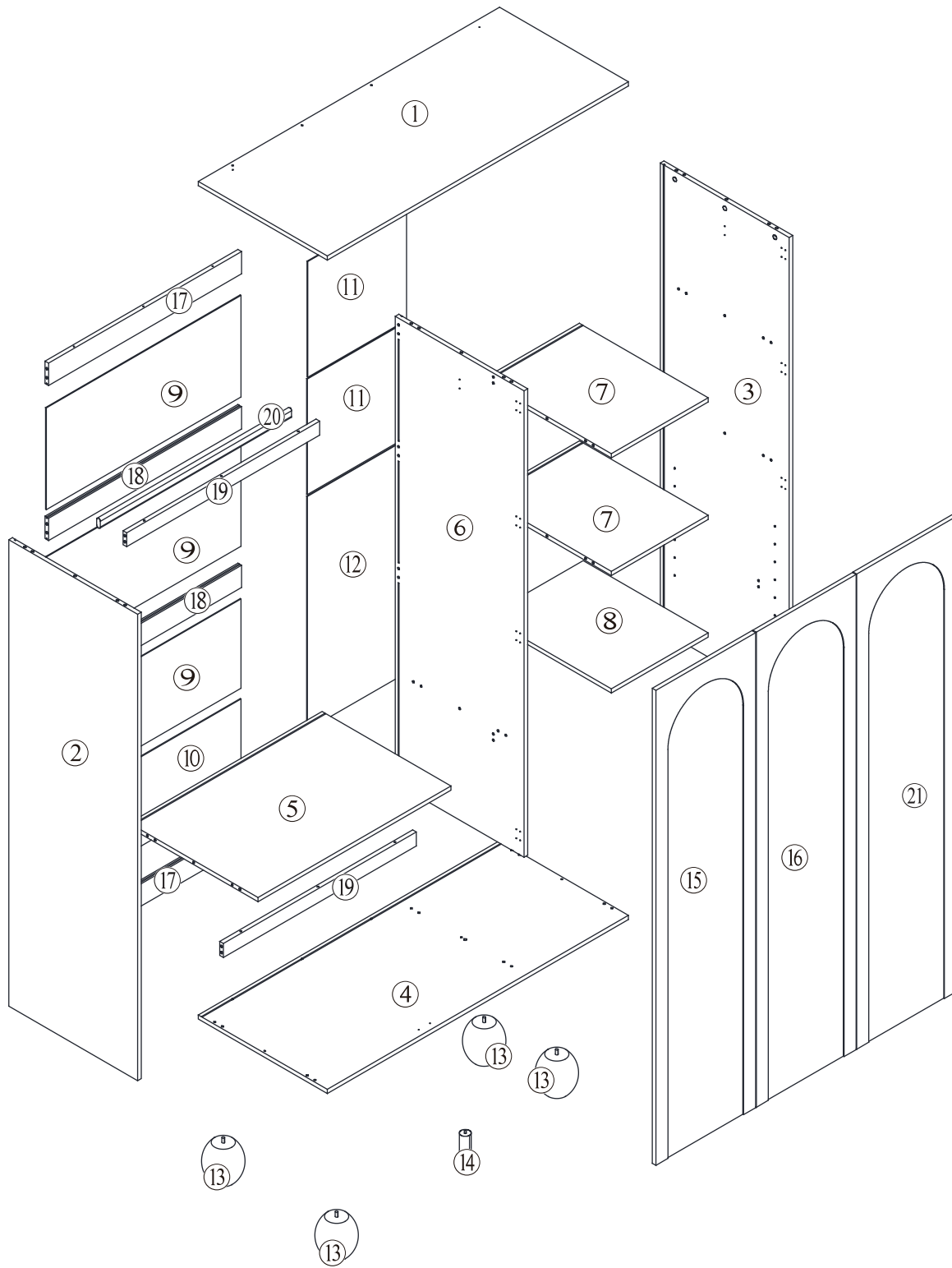

Parts list











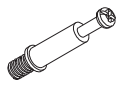

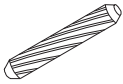
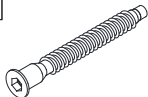
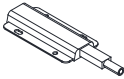
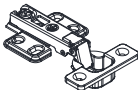

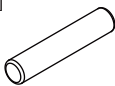



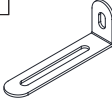

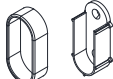
Before you begin building your Rachel 3 door wardrobe, please take a moment to read through the instructions and make sure that you have all the relevant parts listed on the parts check list.

Part Number	Part Description	Quantity	Box No
①	Top Panel	1pc	Box 2
②	Left Side Panel	1pc	Box 2
③	Right Side Panel	1pc	Box 2
④	Bottom Panel	1pc	Box 2
⑤	Left Fixed Shelf	1pc	Box 1
⑥	Divider Panel	1pc	Box 1
⑦	Right Fixed Shelf	2pcs	Box 1
⑧	Adjustable Shelf	1pc	Box 1
⑨	Back Panel	3pcs	Box 1
⑩	Back Panel	1pcs	Box 1
⑪	Back Panel	2pcs	Box 1
⑫	Back Panel	1pc	Box 1

Part Number	Part Description	Quantity	Box No
⑬	Leg	4pcs	Box 1
⑭	Middle Leg	1pc	Box 1
⑮	Left Door Panel	1pc	Box 1
⑯	Middle Door Panel	1pcs	Box 1
⑰	Back Rail	2pcs	Box 1
⑱	Back Rail	2pcs	Box 1
⑲	Front Trim	2pcs	Box 1
⑳	Clothes Poles	1pc	Box 1
㉑	Right Door Panel	1pc	Box 2

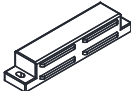

Fittings

Please check you have all the fittings listed below with your product in box 1.

<p>A</p>  <p>M6*35mm Bolt 47pcs+3pcs extra</p>	<p>B</p>  <p>15*10mm Cam Lock 47pcs+3pcs extra</p>	<p>C</p>  <p>8*30mm Dowel 28pcs+2pc extra</p>	<p>D</p>  <p>7*60mm Screw 9pcs+1pcs extra</p>	<p>E</p>  <p>Pusher 3pcs</p>
<p>F</p>  <p>Hinge 12 pcs</p>	<p>G</p>  <p>M3.5*14mm Screw 76pcs</p>	<p>H</p>  <p>Shelf Pin 4pcs</p>	<p>I</p>  <p>Plastic Buckle 44pcs+2pcs extra</p>	<p>J</p>  <p>M3*16mm Screw 48pcs+2pcs extra</p>
<p>K</p>  <p>M4*50mm Screw 6pcs</p>	<p>L</p>  <p>Wall Bracket 2pcs</p>	<p>M</p>  <p>M4*12mm Screw 14 pcs</p>	<p>N</p>  <p>Wall Plug 2pcs</p>	<p>O</p>  <p>Clothes Tray 2pcs</p>
<p>P</p>  <p>Adjustable foot pads 1pc</p>	<p>Q</p>  <p>Pad 4pcs</p>	<p>R</p>  <p>Cover 9pcs+1pc extra</p>	<p>S</p>  <p>M4*35mm Screw 8pcs</p>	<p>T</p>  <p>Metal plate 3pcs</p>
<p>U</p>  <p>M3*12mm Screw 3pcs</p>	<p>V</p>  <p>M3*10mm Screw 3pcs</p>	<p>W</p>  <p>Magnet 1pc</p>	<p>X</p>  <p>Magnet 1pc</p>	<p>Y</p>  <p>Wrench 1pc</p>

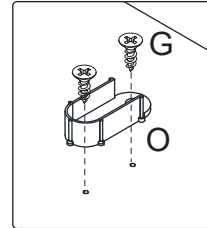
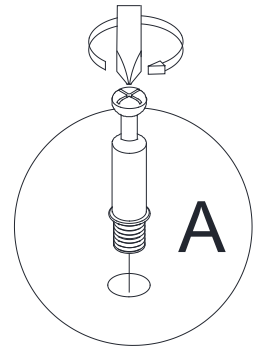
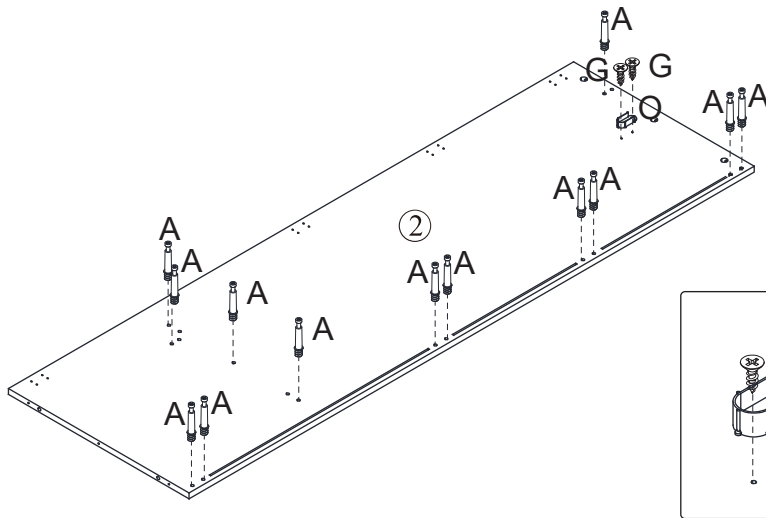

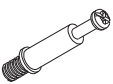

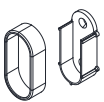
1.Attach parts to the boards.

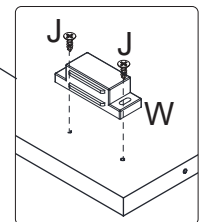
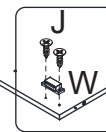
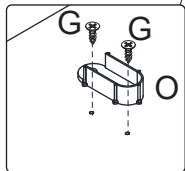
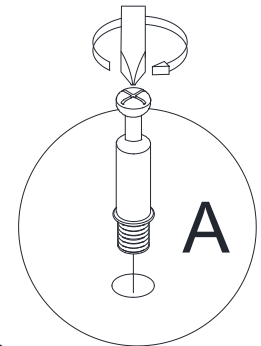
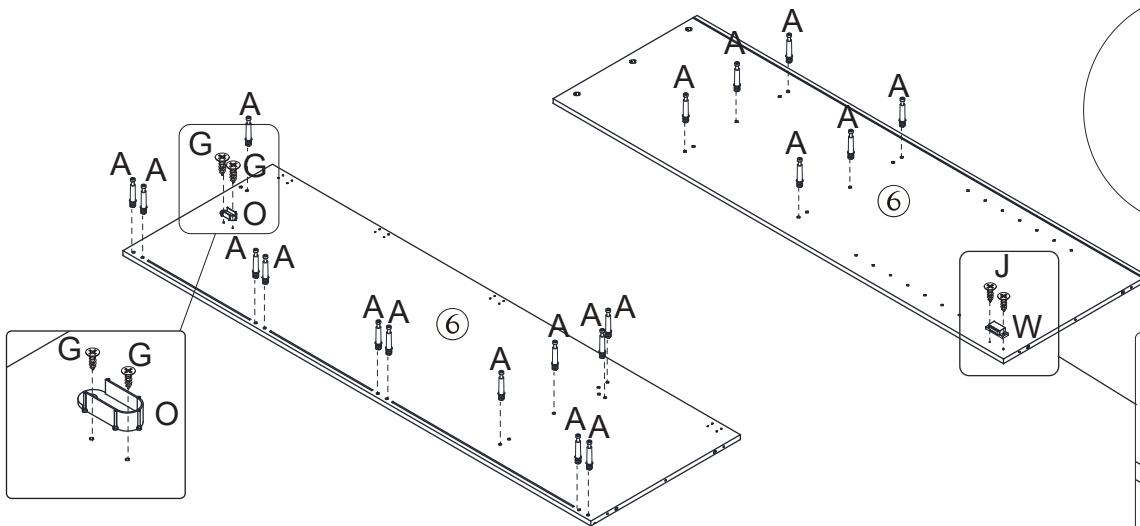

		
M6*35mm Bolt 13pcs	M3.5*14mm Screw 2pcs	Clothes Tray 1pcs

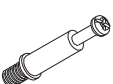
2.Attach parts to the boards.

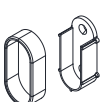

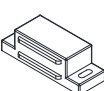
				
M6*35mm Bolt 19pcs	M3.5*14mm Screw 2pcs	Clothes Tray 1pcs	M3*16mm Screw 2pcs	Magnet 1pcs

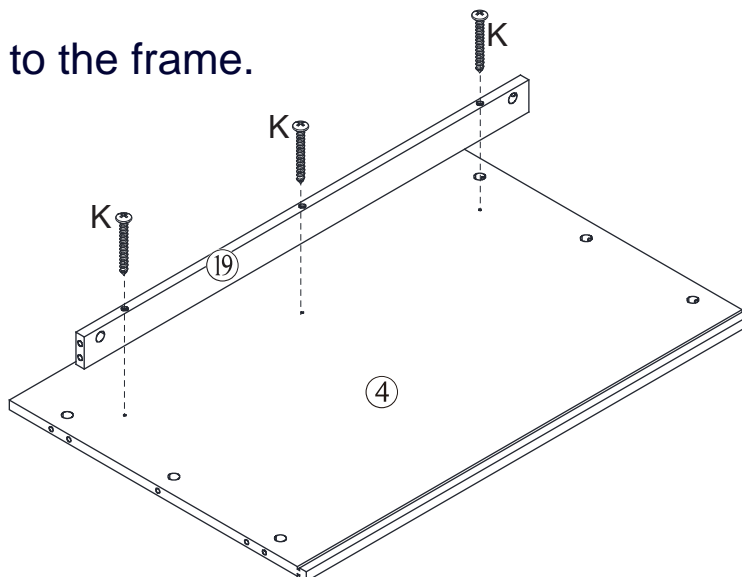

3. Assemble boards to the frame.

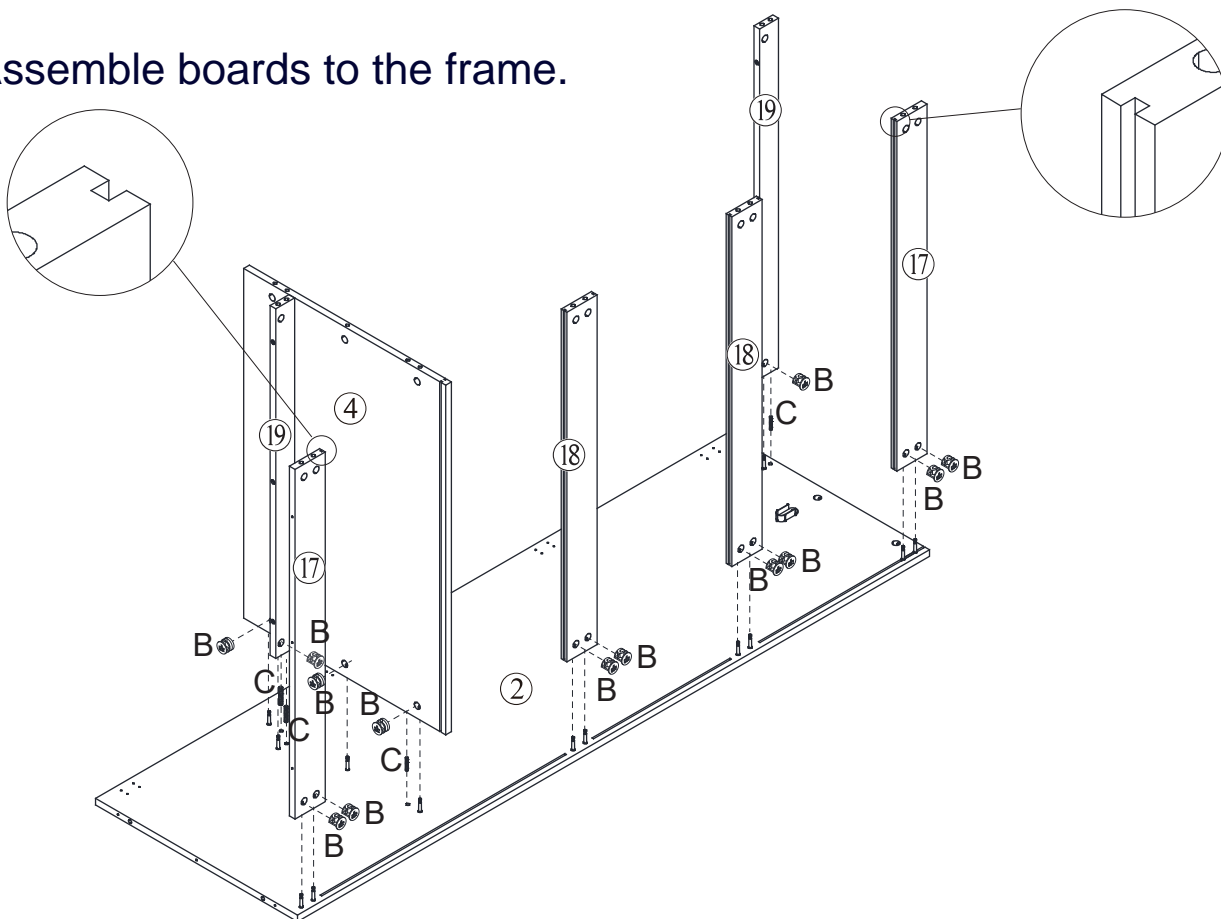

K	
M4*50mm Screw	
3pcs	

4. Assemble boards to the frame.



C		B	
8*30mm Dowel		15*10mm Cam Lock	
4pcs		13pcs	

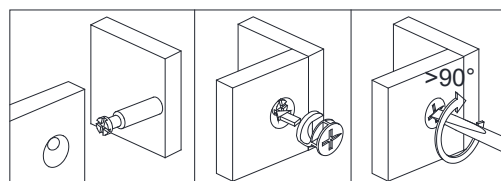

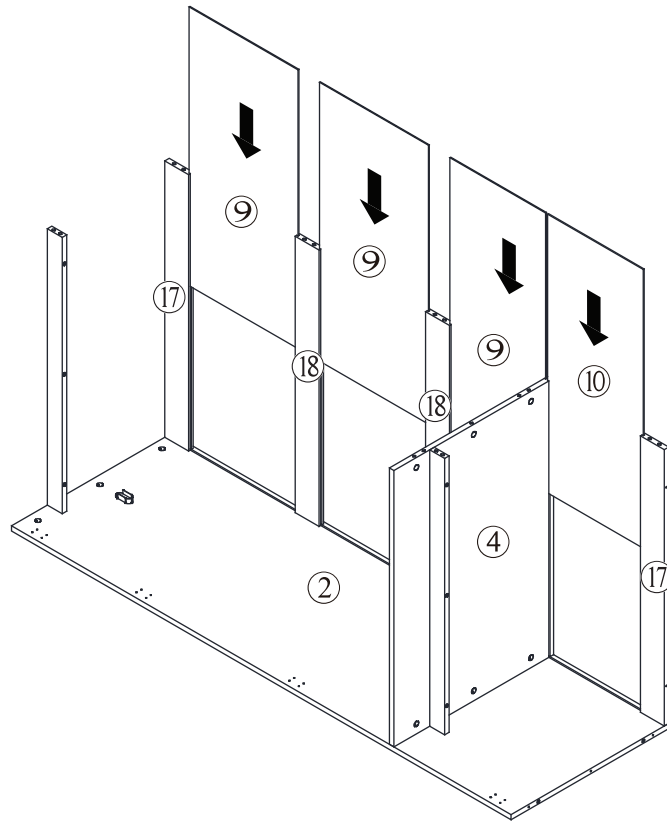

5.

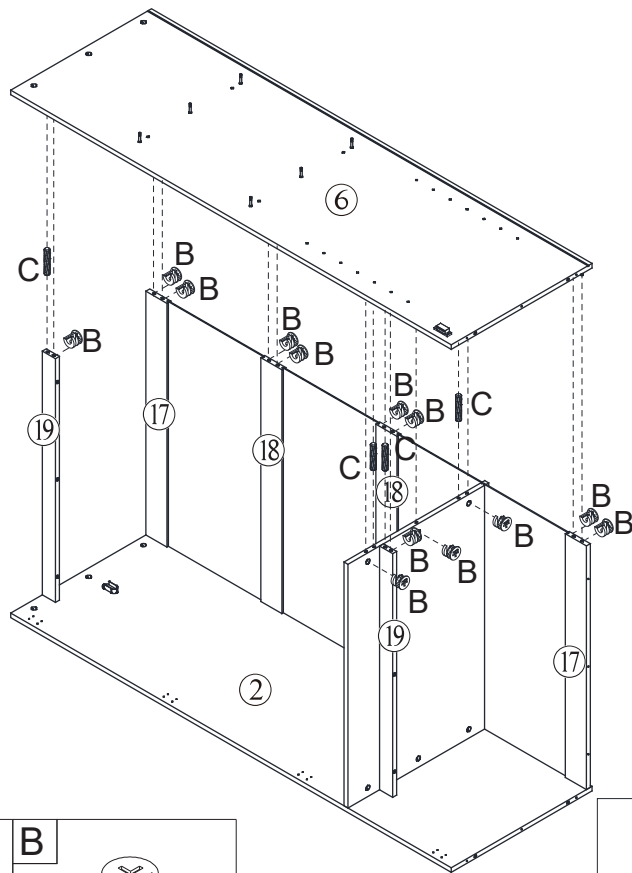

6.



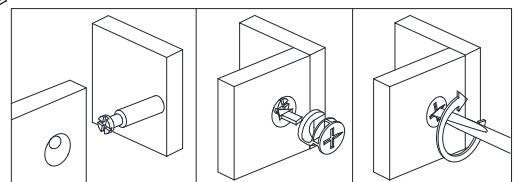

<p>C</p> 	<p>B</p> 
<p>8*30mm Dowel 4pcs</p>	<p>15*10mm Cam Lock 13pcs</p>

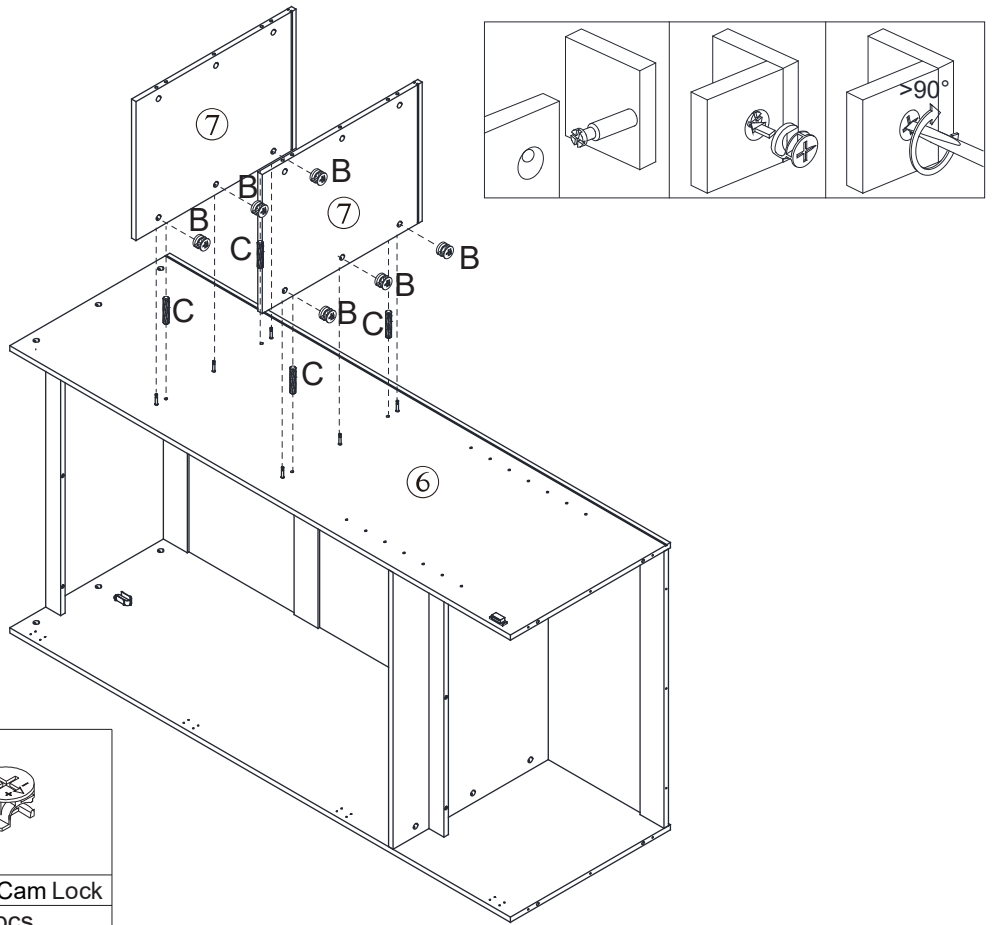

7.



<p>C</p> 	<p>B</p> 
<p>8*30mm Dowel 4pcs</p>	<p>15*10mm Cam Lock 6pcs</p>

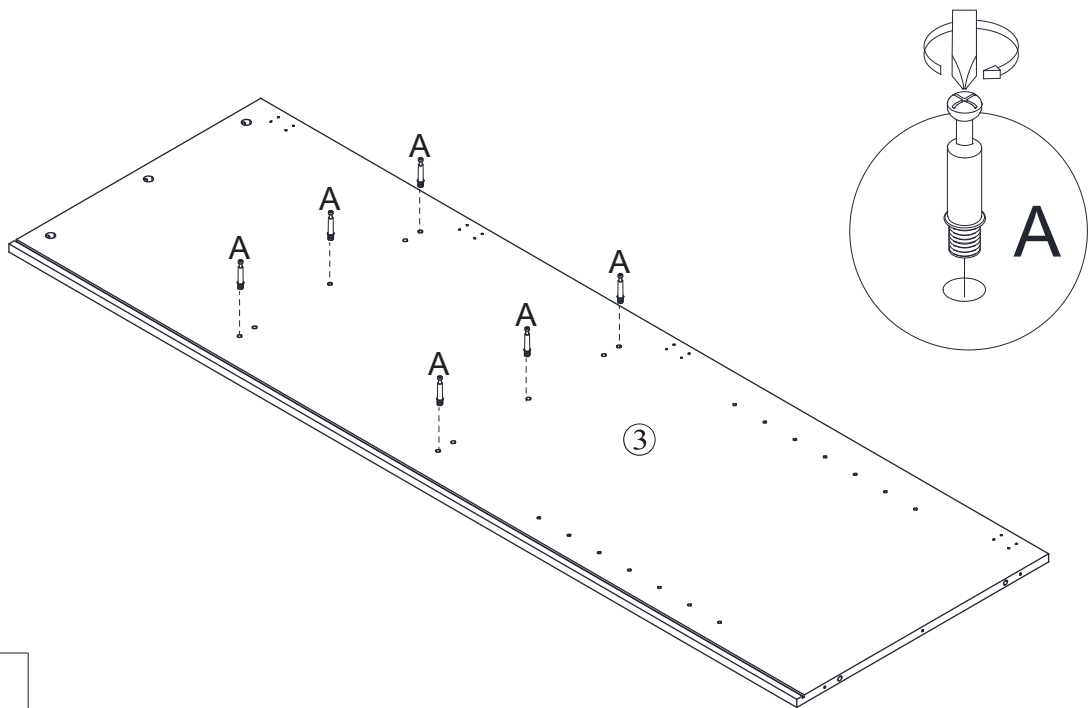

8.

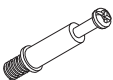

<p>A</p> 
<p>M6*35mm Bolt 6pcs</p>

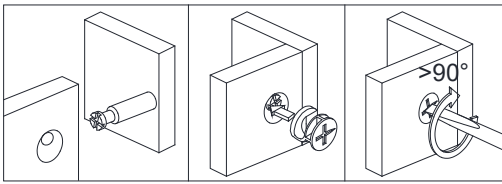
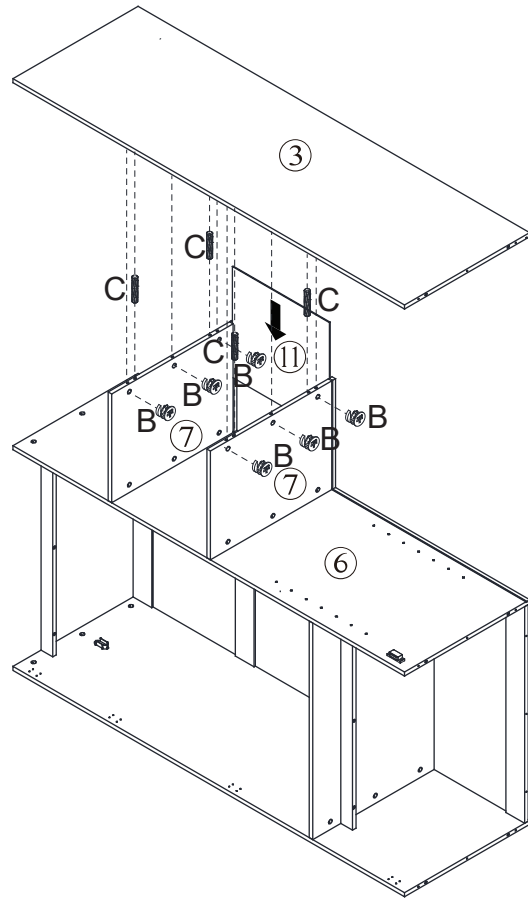
9.



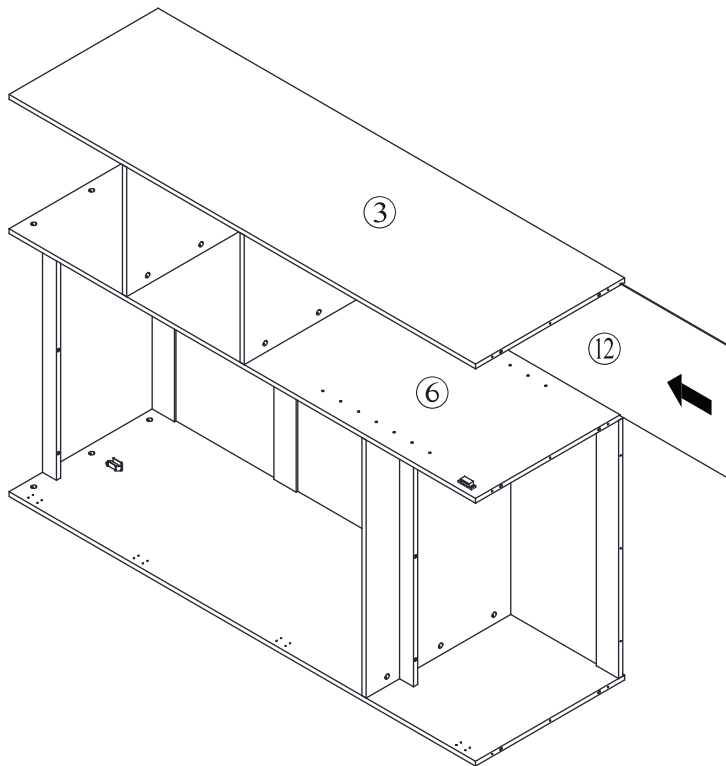

C		B	
	8*30mm Dowel 4pcs		15*10mm Cam Lock 6pcs

10.



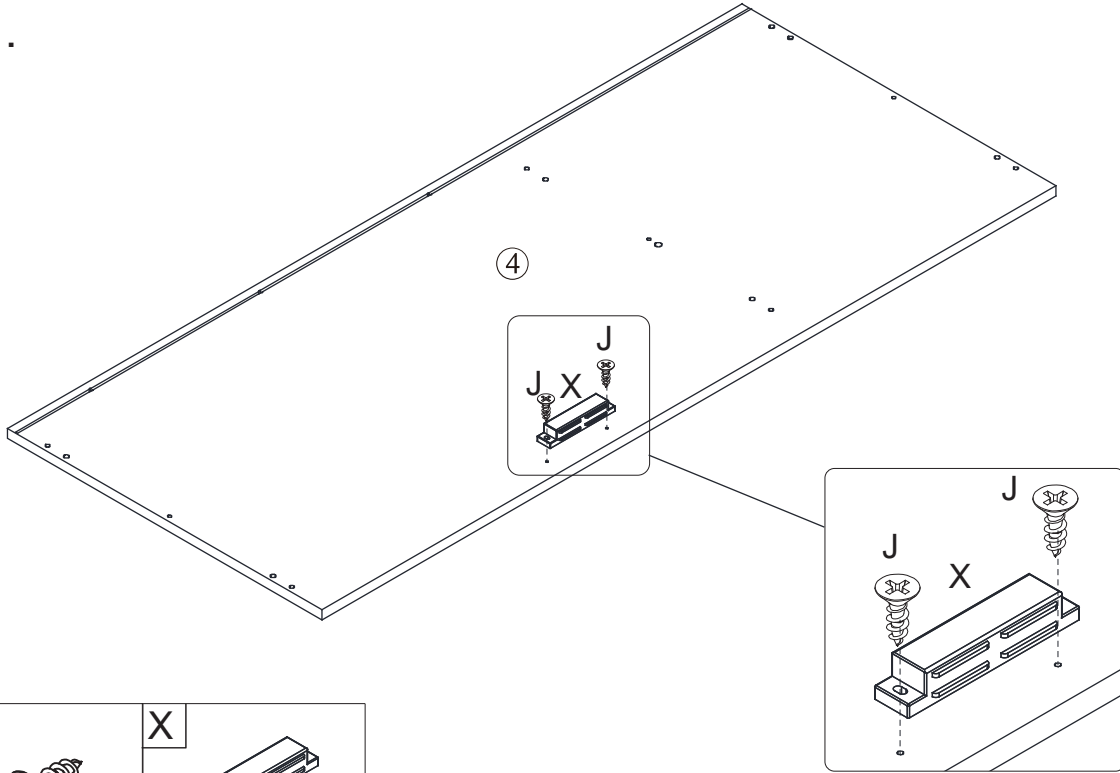

11.

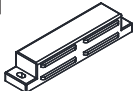

<p>J</p> 	<p>X</p> 
<p>M3*16mm Screw 2pcs</p>	<p>Magnet 1pcs</p>

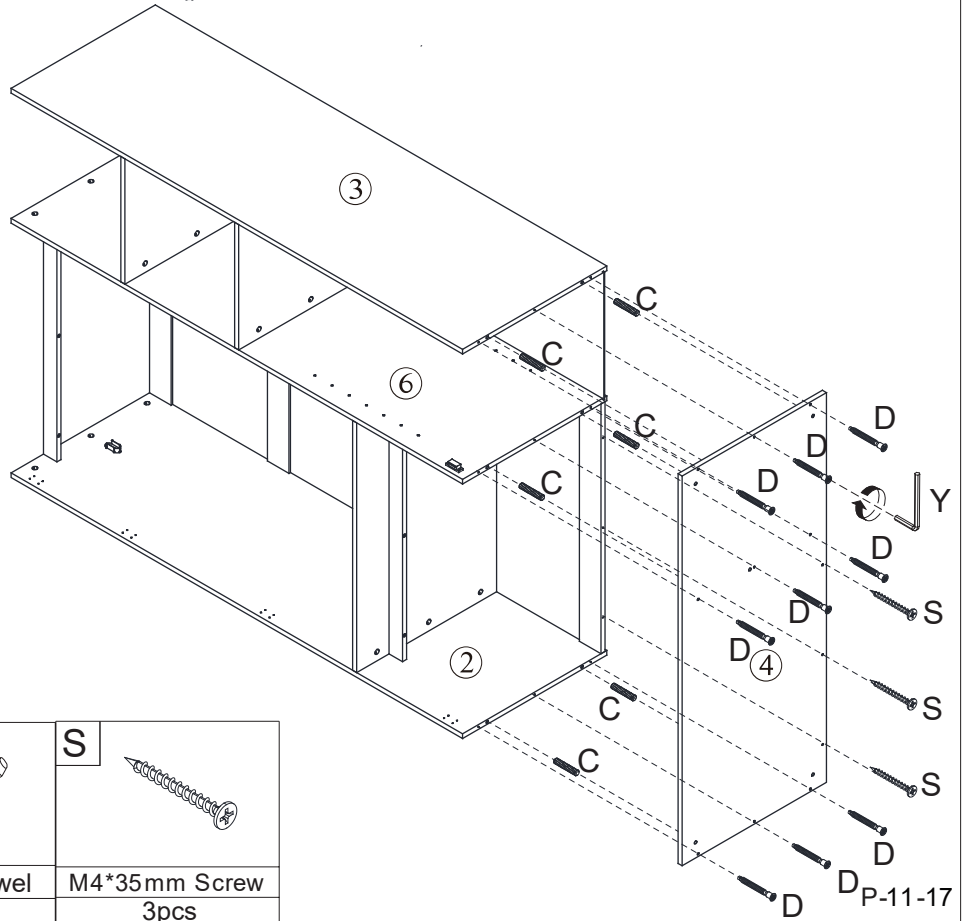
12.



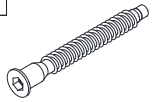
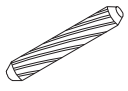
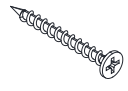

<p>Y</p> 
<p>Wrench 1 pc</p>

<p>D</p> 	<p>C</p> 	<p>S</p> 
<p>7*60mm Screw 9 pcs</p>	<p>8*30mm Dowel 6pcs</p>	<p>M4*35mm Screw 3pcs</p>

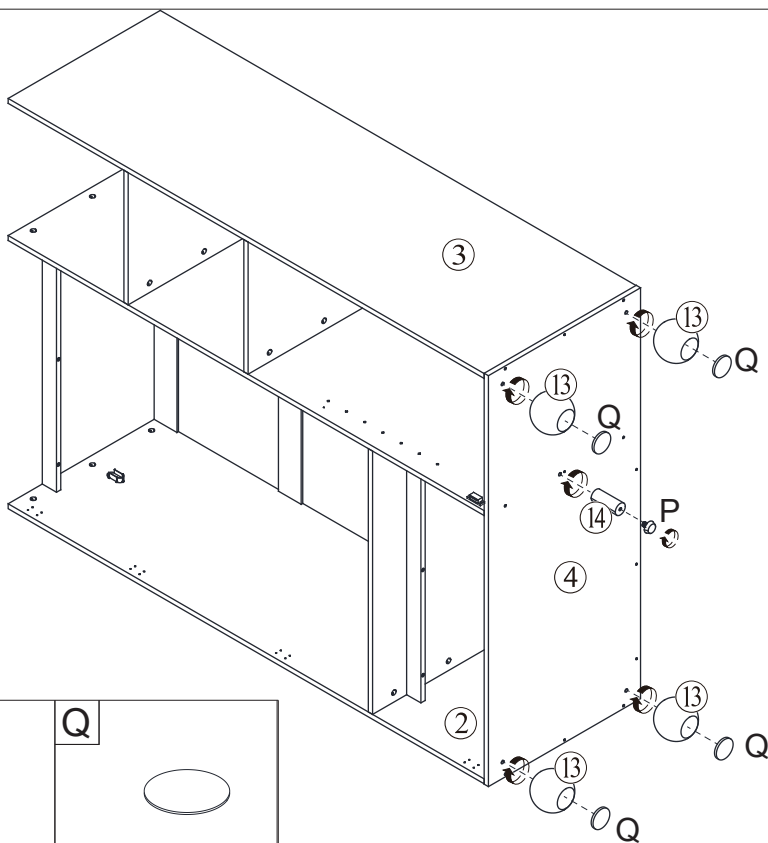

13.

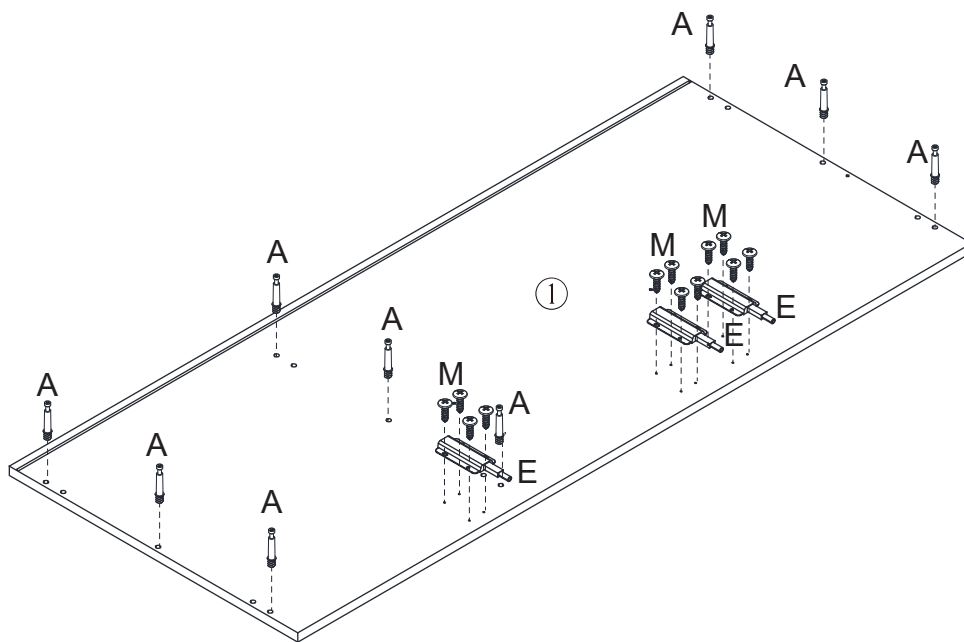

<p>P</p> 	<p>Q</p> 
<p>Adjustable foot pads 1pcs</p>	<p>Pad 4pcs</p>

14.

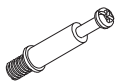
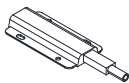

<p>A</p> 	<p>E</p> 	<p>M</p> 
<p>M6*35mm Bolt 9 pcs</p>	<p>Pusher 3 pcs</p>	<p>M4*12mm Screw 12 pcs</p>



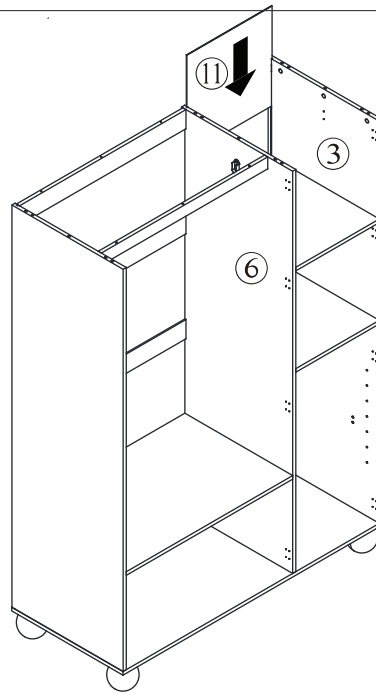

P-12-17
V-1.0

15.

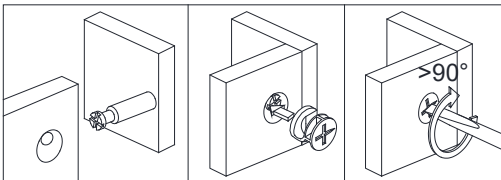
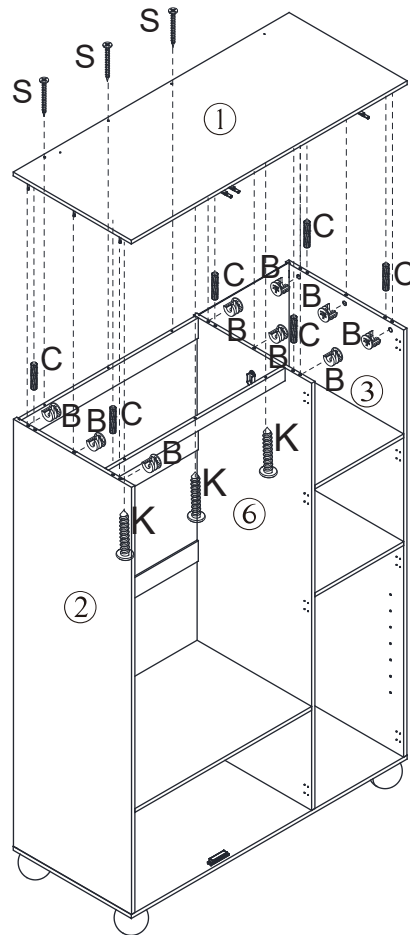

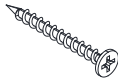

16



C	B	S	K
			
8*30mm Dowel 6pcs	15*10mm Cam Lock 9pcs	M4*35mm Screw 3pcs	M4*50mm Screw 3pcs

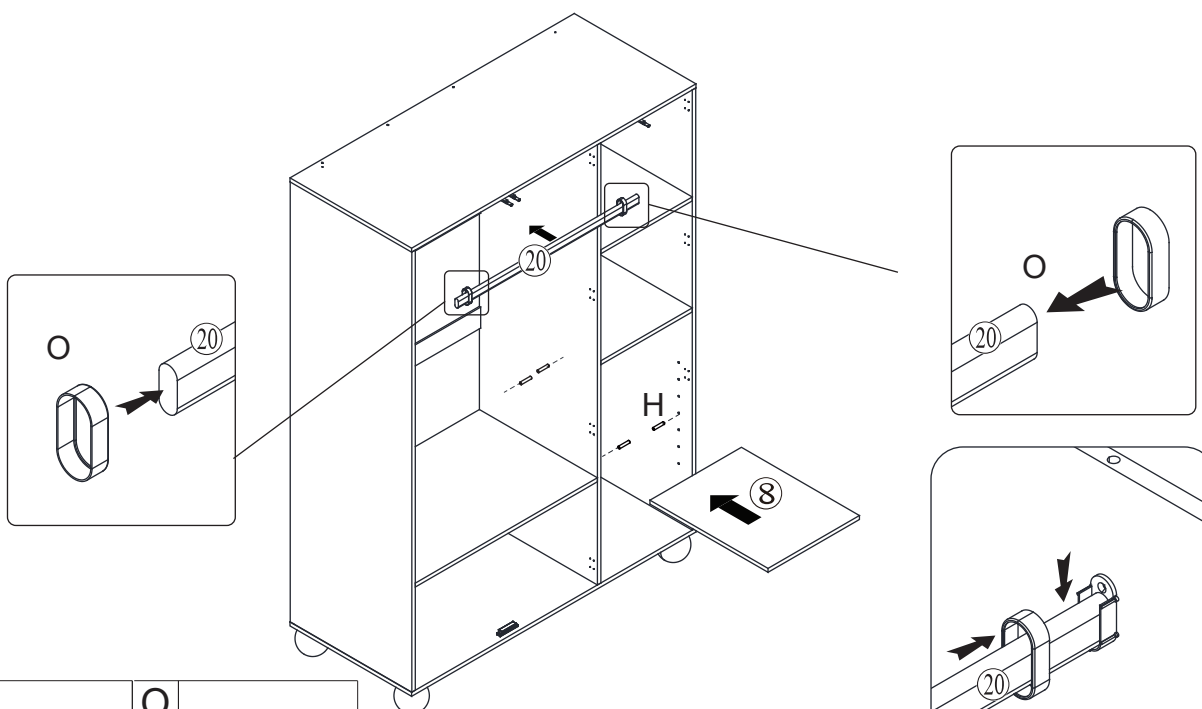

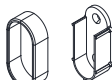

17.

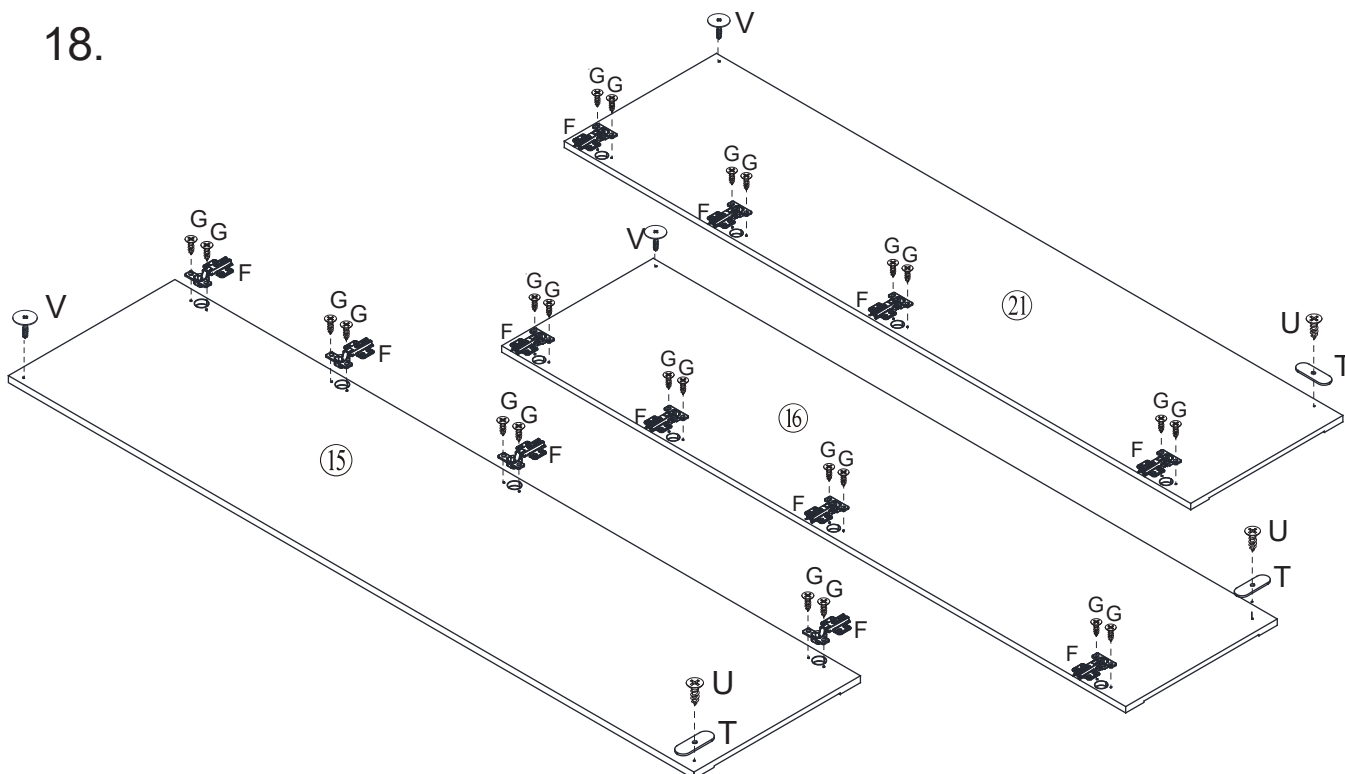

<p>H</p> 	<p>O</p> 
<p>Shelf Pin 4pcs</p>	<p>Clothes Tray 2pcs</p>

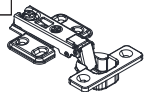
18.





<p>F</p> 	<p>G</p> 	<p>U</p> 	<p>T</p> 	<p>V</p> 
<p>Hinge 12 pcs</p>	<p>M3.5*14mm Screw 24 pcs</p>	<p>M3*12mm Screw 3 pcs</p>	<p>Metal plate 3 pcs</p>	<p>M3*10mm Screw 3 pcs</p>

P-14-17
V-1.0

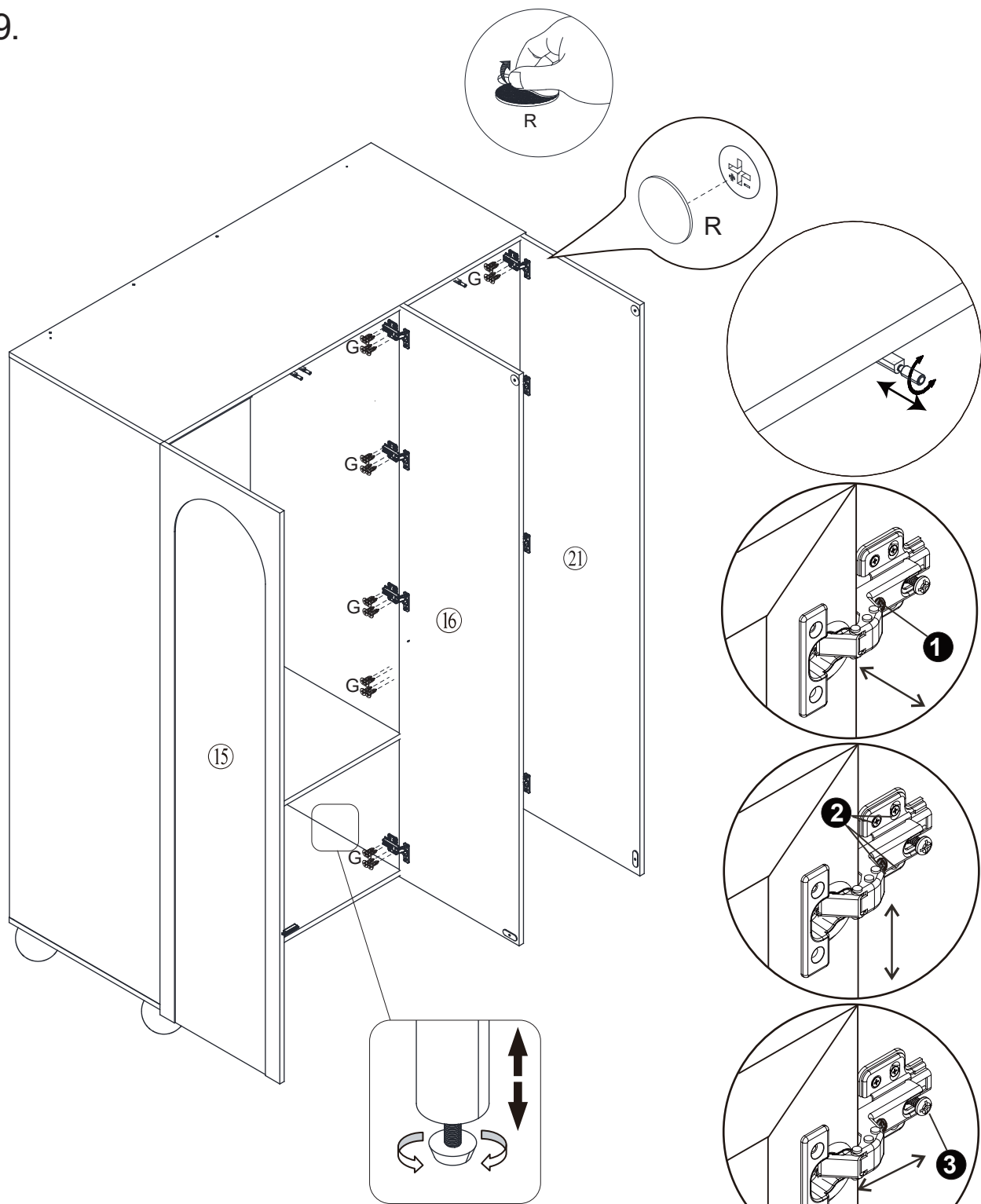
19.



<p>R</p> 	<p>G</p> 
<p>Cover 9 pcs</p>	<p>M3.5*14mm Screw 48 pcs</p>

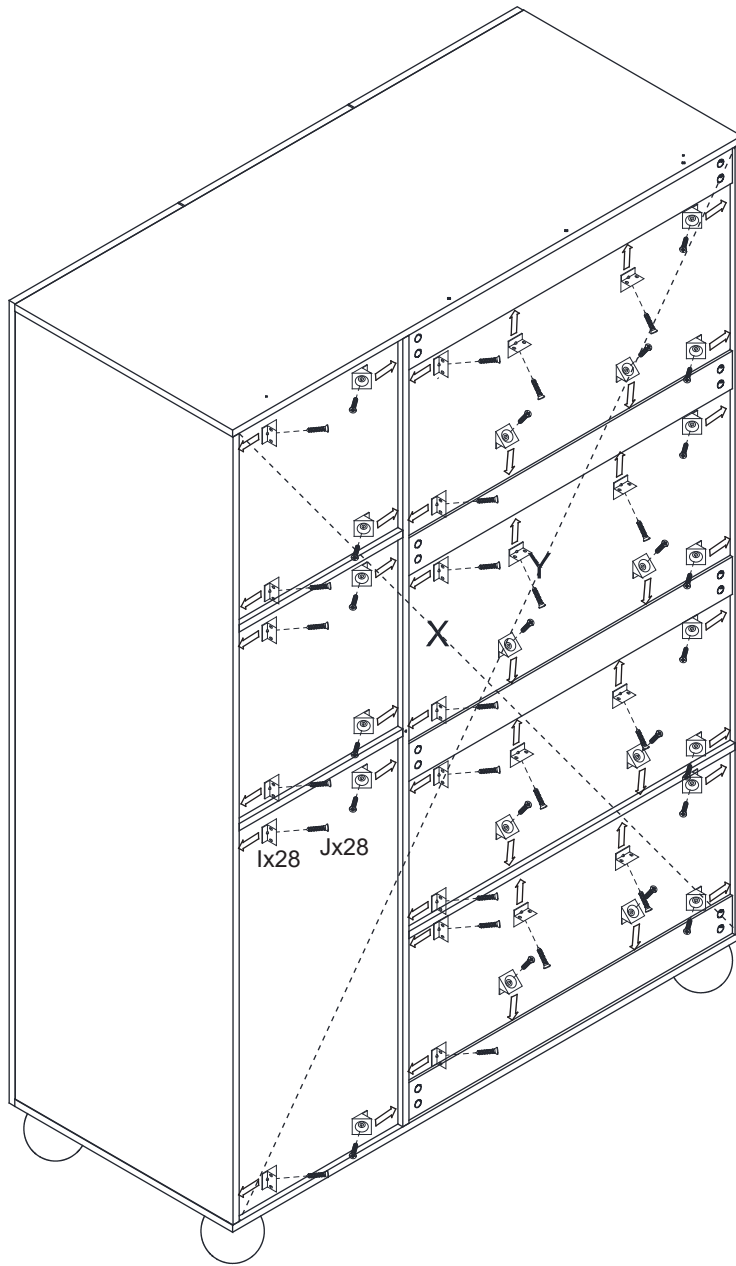

P-15-17
V-1.0

20.

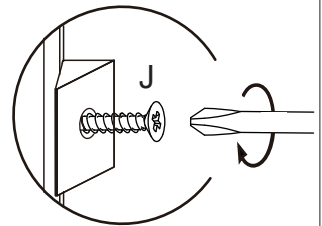
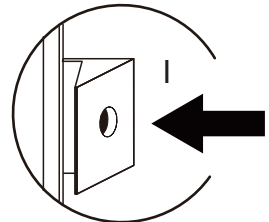
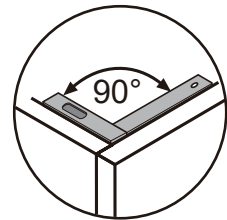

X=Y





J	I
	
M3*16mm Screw 44pcs	Plastic Buckle 44pcs

P-16-17
V-1.0

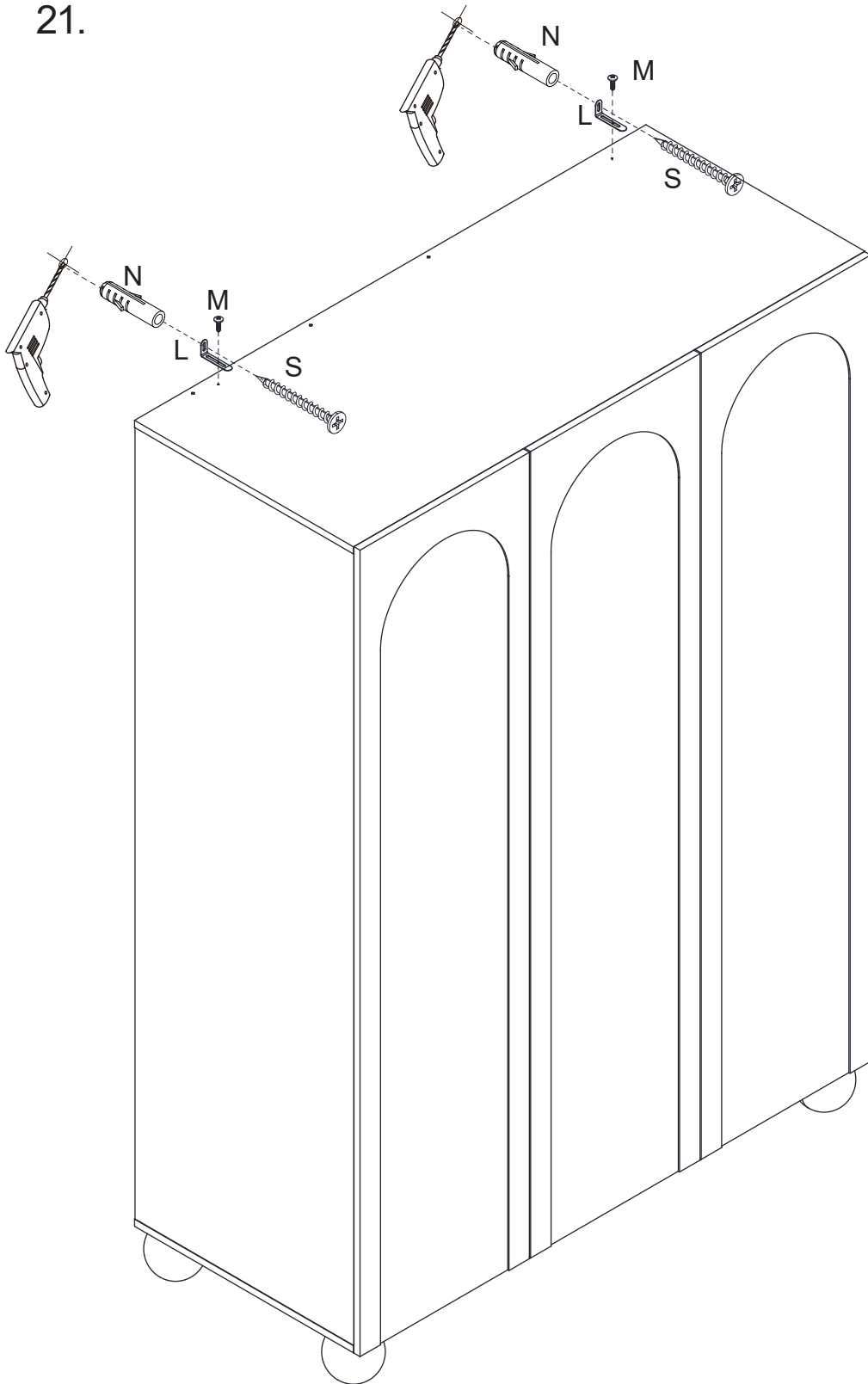
21.

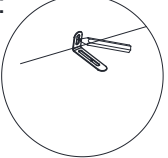
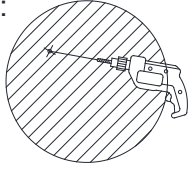
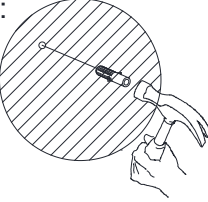
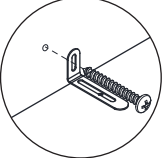

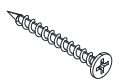
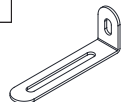
- 1: 
- 2: 
- 3: 
- 4: 

<p>S</p> 	<p>L</p> 	<p>M</p> 	<p>N</p> 
<p>M4*35mm Screw 2pcs</p>	<p>Wall Bracket 2pcs</p>	<p>M4*14mm Screw 2pcs</p>	<p>Wall Plug 2pcs</p>