

DUSK.COM

LIVING | BEDROOM | DINING

Range Name: Heidi

Box Dimensions: L170x W100 x H14(cm)

Heidi Rectangular Dining Table

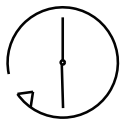
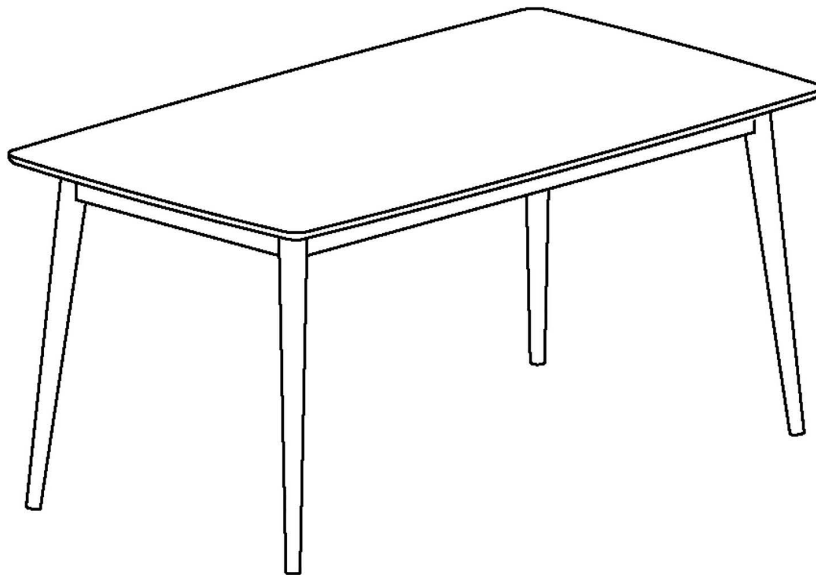

Up to 30 minutes
assembly time

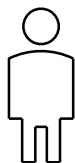

One person
assembly

This product is intended for domestic use only, not for commercial purpose.

IMPORTANT

ASSEMBLY TIP

Before you begin, we advise laying everything out on a clean and soft level surface to avoid damaging the unit or your floor. It's best to identify all of the parts and fittings to build your dining bench, and to familiarise yourself with all of the parts and fittings before building.

TOP TIP

We recommend that you assemble the bench in the room you'd like it to be used. This will help prevent the chance of damaging the item when moving it around.

SAFETY AND CARE

It's important to ensure children and animals are kept away from the assembly area, as there are small components used in this product which could present a choking hazard. All plastic and wrapping materials should also be kept away from children and animals to prevent any risk of suffocation.

Do not stand on your product. Pregnant women should take additional care when using this product. Do not leave the children unattended. Children should always be under direct adult supervision whilst using this product.

Always use on firm level ground, ensuring all legs remain in contact with the ground.

HELP AND SUPPORT

Please contact our customer service team on 0113 519 0311 if you have any questions or issues with your purchase.

RECYCLING

Please ensure that packaging is disposed of in a safe and environmentally friendly way, and recycle where possible. Please keep your assembly instructions safe to refer back to in the future.

CARE AND MAINTENANCE

1. Only clean using a damp cloth, do not use bleach or abrasive cleaners as they may damage the finish over time.
2. Do not use a very wet cloth or allow any liquid to contact with the veneer for a long period of time. Wipe any spillage immediately. Absorption can cause wood to warp or finishes to de-laminate.
3. Do not scrub or rub the surface when cleaning.
4. Do not drag the dining bench when moving, lift it off the floor instead.
5. Use a placemat or a coaster when putting hot items (e.g. hot drinks and dishes) on the wood surface.
6. It is not recommended to place the item next to sources of heat such as radiators, fires or directly exposed to sunlight. This may cause the wood to crack, split or fade due to the change of the humidity and temperature.
7. Wood will mellow and change colour over time, we recommend that ornaments and items placed on the surface to be moved regularly to prevent uneven mellowing.
8. Regularly check all fixings to ensure none have come loose. Re-tighten if necessary.
9. Avoid sharp items such as a screwdriver or any pointy tools.



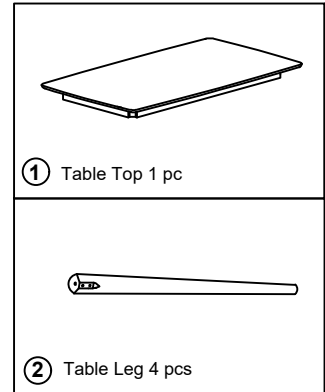
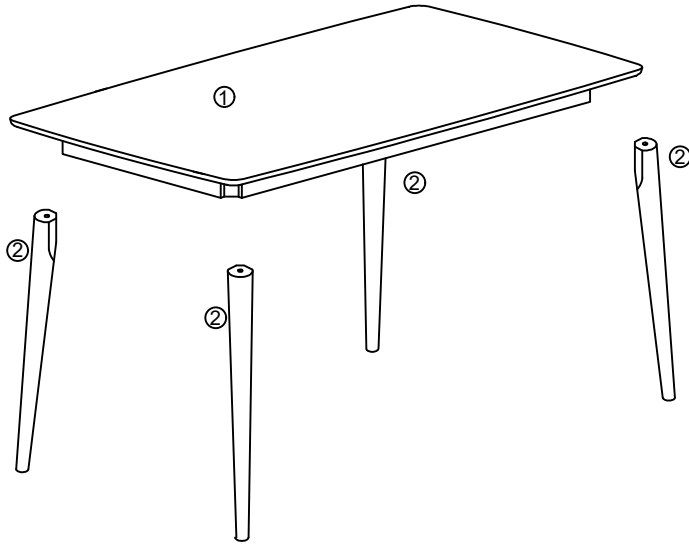

Parts list

Before you start to build your Heidi dining table, please take a moment to read through the instructions and make sure that you have all the relevant parts listed on the parts checklist.



Fittings list

Please check you have all the fittings listed below with your product.

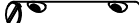
 <p>A M8 Flat washer 9 pcs (1 extra)</p>	 <p>B M8 Spring washer 9 pcs (1 extra)</p>	 <p>C M8 Nut 9 pcs (1 extra)</p>	 <p>D Spanner 1 pc</p>
 <p>E M8x80mm Bolt 9 pcs (1 extra)</p>	 <p>F Ø12x60mm Nut 4 pcs</p>		

Bolt Length Ruler

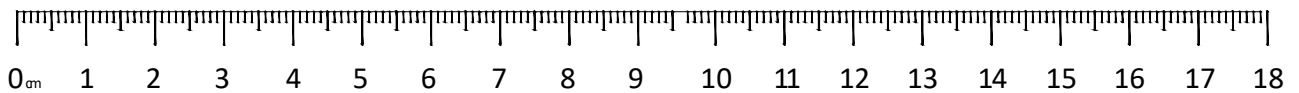

Tool Required (not provided)

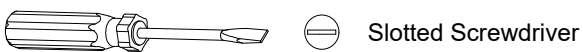



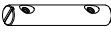

Step 1: Get the legs ready for assembly.

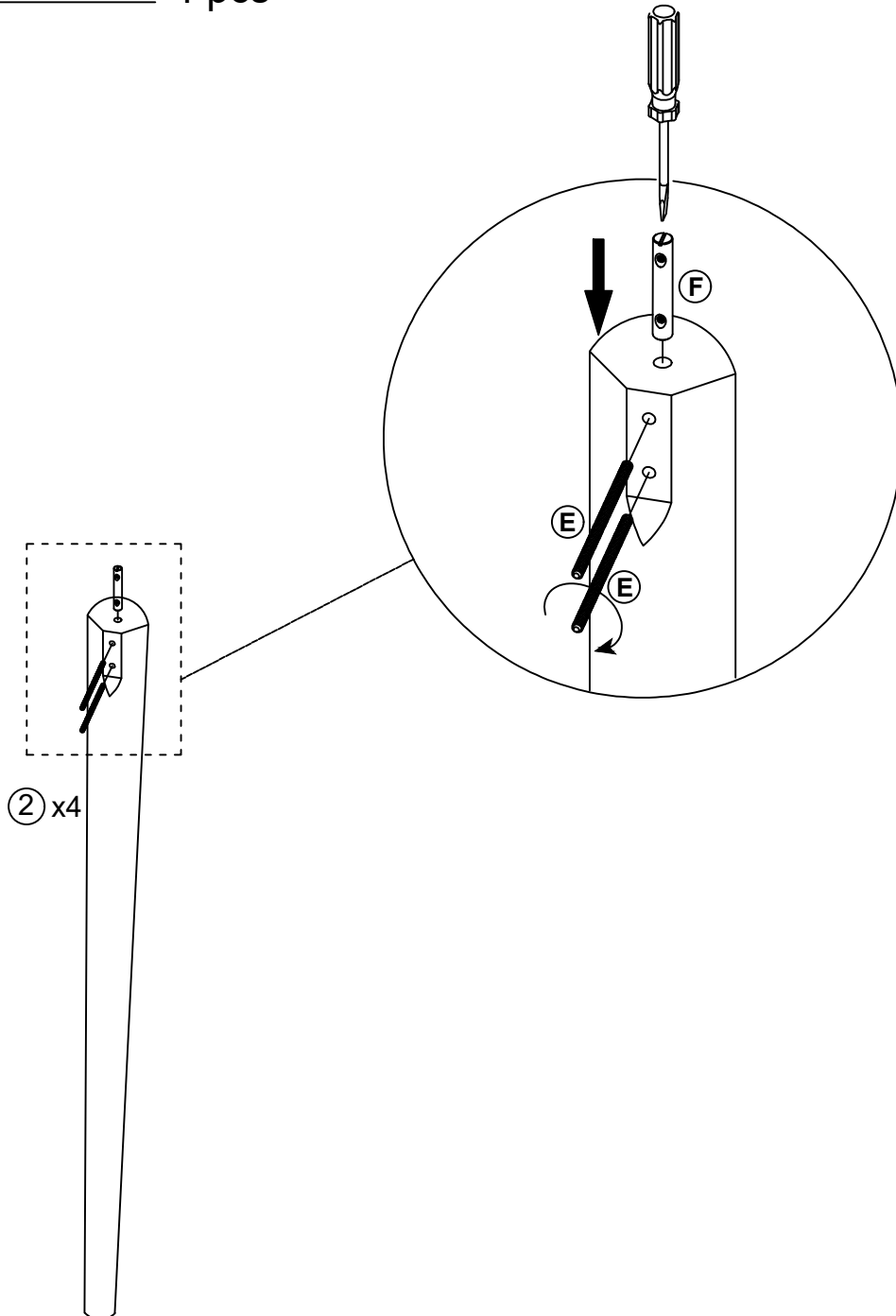
E  8 pcs

F  4 pcs



Step 2: Attaching the legs to the table top.

- A  8 pcs
- B  8 pcs
- C  8 pcs
- D  1 pc

