

# DUSK.COM

LIVING | BEDROOM | DINING

## Hampshire Chaise 2 Seater

Box dimensions: W160x D92 x H57 (cm)

Product dimension: W154 x D90 x H85 (cm)

Full assembled dimension : W238 x D163 x H85 (cm)

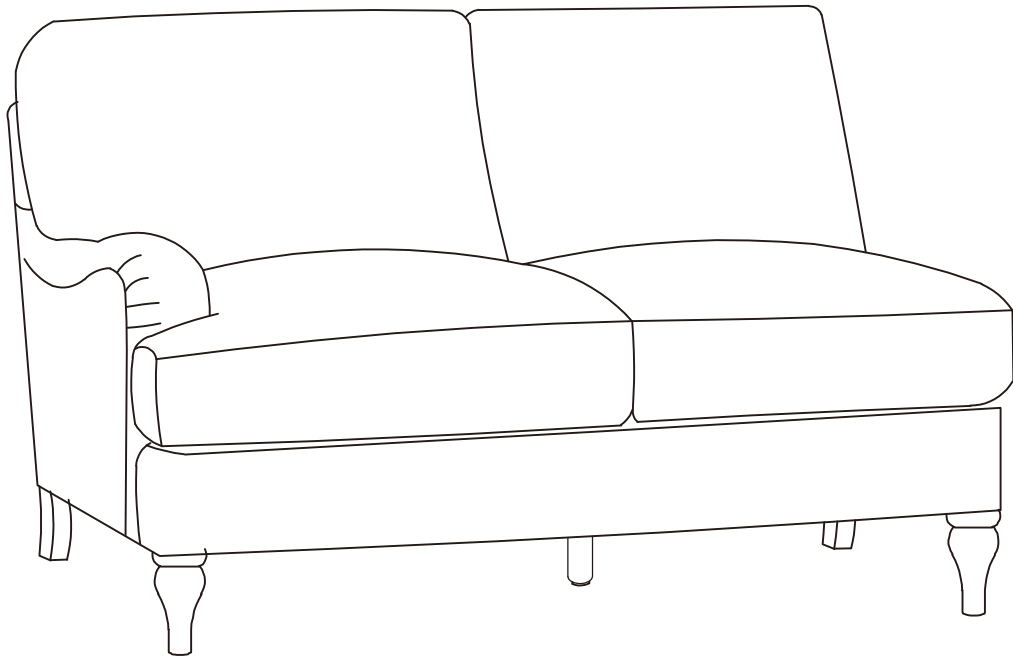

THIS INSTRUCTION BOOKLET CONTAINS IMPORTANT SAFETY INFORMATION.  
PLEASE READ AND KEEP FOR FUTURE REFERENCE.



20 minutes approx  
assembly time

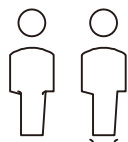

Two adults  
assembly required

This product is intended for domestic use only, not for commercial purposes.

P-1-5  
V-2.0

# Parts checklist

Please check you have all the parts listed below with your product:



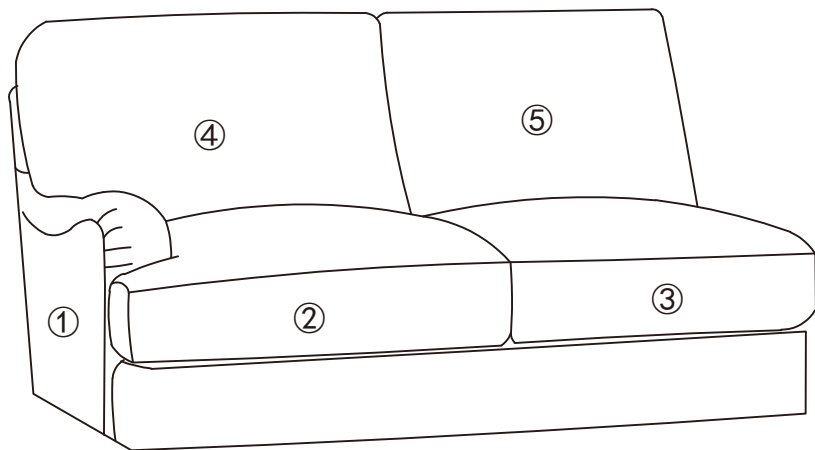



Do not discard any of the packaging until you have checked that you have all the parts and the pack of fixings.



NO.	Parts List	QTY
1	Frame	1pc
2	Left Seat Cushion	1pc
3	Right Seat Cushion	1pc
4	Left Back Pillow	1pc
5	Right Back Pillow	1pc

# Fittings checklist

Please check you have all the fittings listed below with your product:

<p>A</p> 	<p>B</p> 	<p>C</p> 	<p>D</p> 	<p>E</p> 
<p>Bolt M8 x 65mm</p>	<p>M5 Allen key</p>	<p>Front Leg</p>	<p>Plastic washer</p>	<p>Rear leg</p>
<p>2</p>	<p>1</p>	<p>2</p>	<p>2</p>	<p>2</p>
<p>F</p> 	<p>G</p> 			
<p>Wood chipping M8x40mm</p>	<p>Medium foot</p>			
<p>2</p>	<p>1</p>			

# IMPORTANT

## ASSEMBLY TIP

Before you begin, it's best to identify all of the parts and fittings to build your sofa frame. We advise laying these out on the floor to check you have everything, and to familiarise yourself with all of the parts and fittings before building.

## TOP TIP

We recommend that you assemble the sofa in the room you'd like it to be located. This will help prevent any risk of damage to the frame whilst moving it.

## SAFETY AND CARE

It's important to ensure children and animals are kept away from the assembly area, as there are small components used in this product which could present a choking hazard. All plastic and wrapping materials should also be kept away from children and animals to prevent any risk of suffocation.

## HELP AND SUPPORT

Please contact our customer service team on 0113 519 0311 if you have any questions or issues with your purchase.

## RECYCLING

Please ensure that packaging is disposed of in a safe and environmentally friendly way, and recycle where possible. Please keep your assembly instructions safe to refer back to in the future.

# CARE AND MAINTENANCE

- 1.Clean with your vacuum curtain attachment (the one with a lint-catching fabric strip) or a lint roller to stop dust build up. Do this regularly to keep the sofa in its best condition.
- 2.Regularly plump the backrest pillows by shaking and squeezing to even out the filling.
- 3.Try to keep your sofa away from direct sunlight, and not too close to heat sources, as this can cause fading over time. Do not allow the sofa to make direct contact with any radiators or sources of heat.
- 4.Wipe up the spillages as quickly as possible by gently dabbing or blotting with a dry cloth until the mark fades away. Some tougher spills, such as oil and grease, can be more persistent and leave a stain. In this case, it's best to contact a specialist cleaning service.
- 5.Do not drag the sofa. When moving, lift the sofa off the floor.
- 6.Keep children and pets away from the assembly area and any packaging, small parts could choke is swallowed.
- 7.Do not sit on the arms of the sofa.
- 8.Do not jump on the sofa.
- 9.Only use the sofa on a flat and level surface.
- 10.Dispose of all packaging carefully and responsibly - recycle where possible.
- 11.Avoid sharp items such as toys, jean rivets, buckles etc

**Step 1** Open the box to access the hardware.

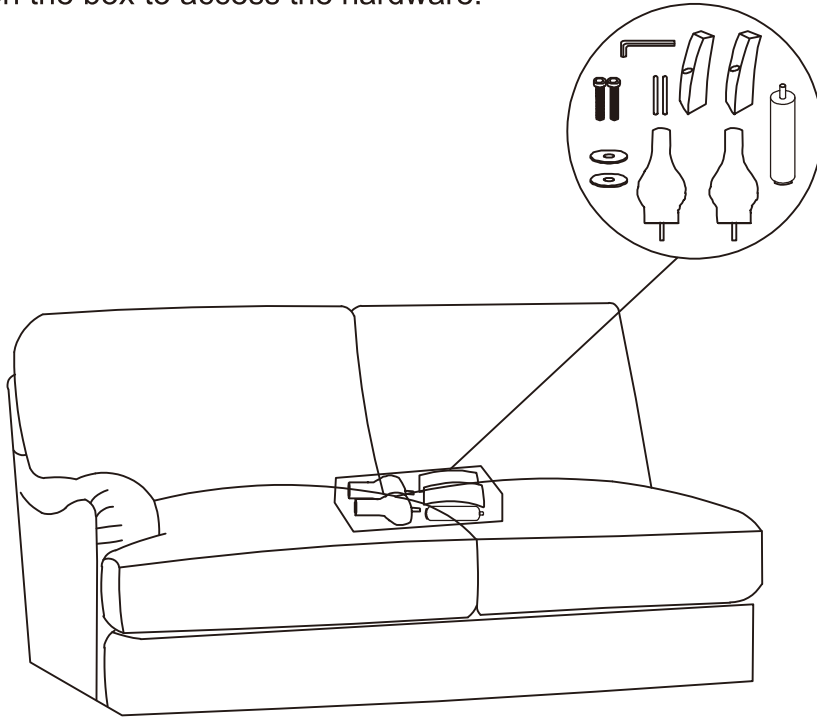

**Step 2** Fasten the front legs, medium foot and affix the rear legs as shown in the above diagram using the bolts supplied.

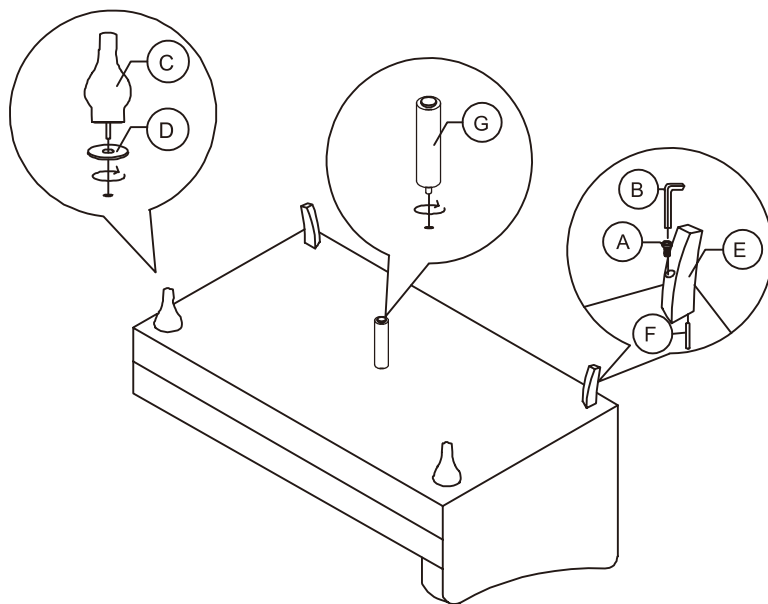

**Step 3-1** Fasten the two sides of the sofa together using the flush interlocking brackets (pre-assembled)

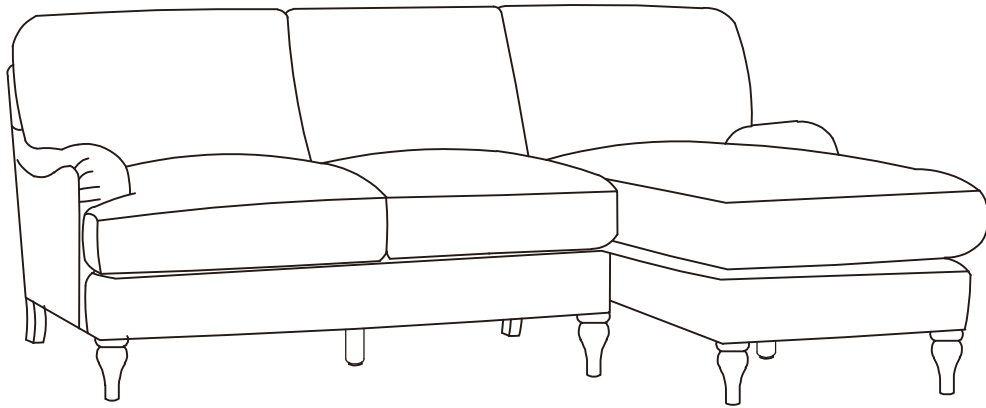
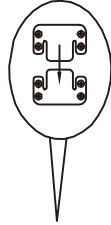

Right Hand Chaise

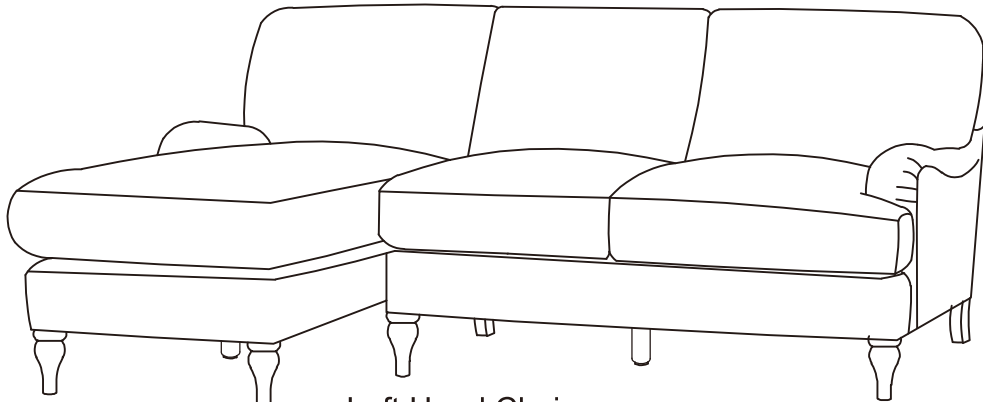
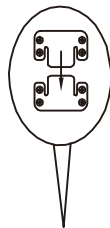

Left Hand Chaise