

DUSK.COM

LIVING | BEDROOM | DINING

Hattie Barstool

Box dimension:W62xD50 xH51.5 (cm)

Product dimension:W49.5 x D47.5 xH97(cm)

HATTIE BARSTOOL

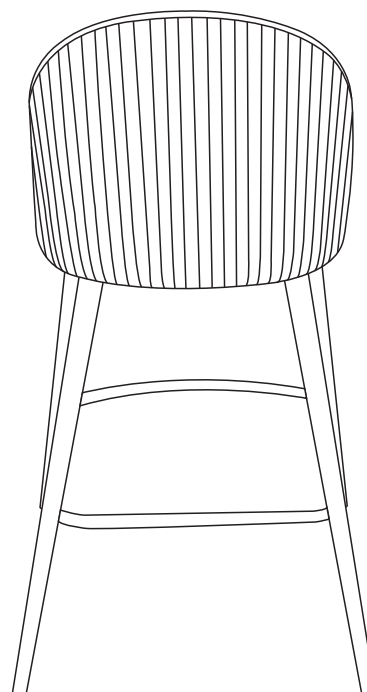
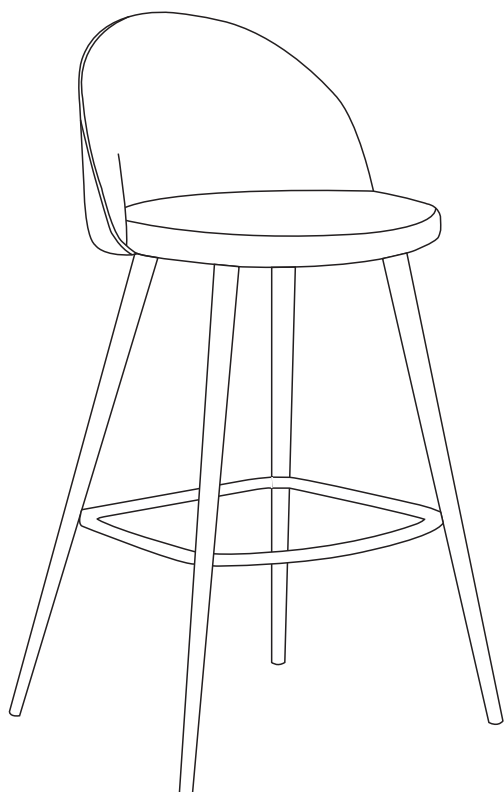

Up to 10 minutes
assembly time





One person
assembly





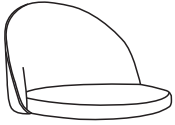

Electric screwdriver
prohibited

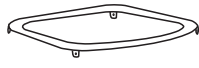
P-1-4
V-2.0

Parts check list



A		B		C		D	
	Seat		Back Leg		Front Leg		
	1pc		2pcs		2pcs		1pc

Fittings check list

E		F		G		H		I	
	8*18*1.2MM		M8*25MM		M6*16MM		M5		Pre-assembled
	8pcs +1pc extra		8pcs +1pc extra		4pcs +1pc extra		1pc		2pcs extra

Components supplied. Please use this guide if you require replacement parts.

Step 1:

- E**  8pc
- F**  8pc
- H**  1pc

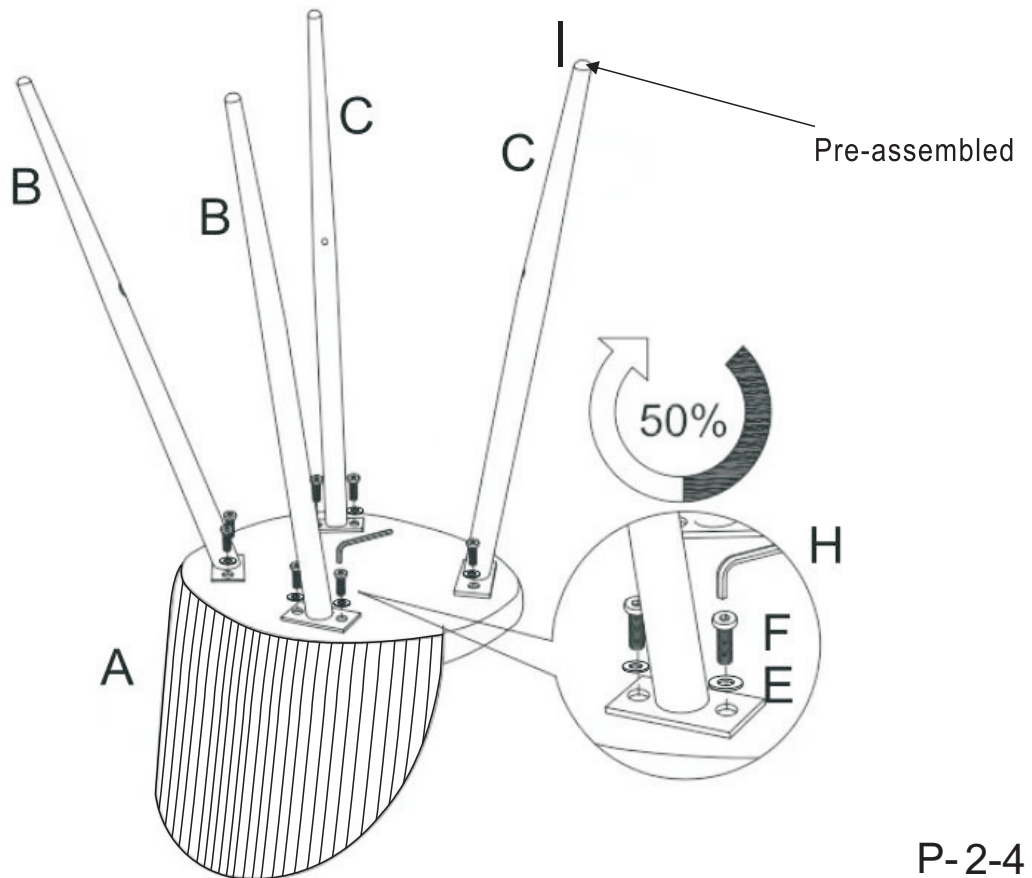

Step 2:

G  4pcs

H  1pc

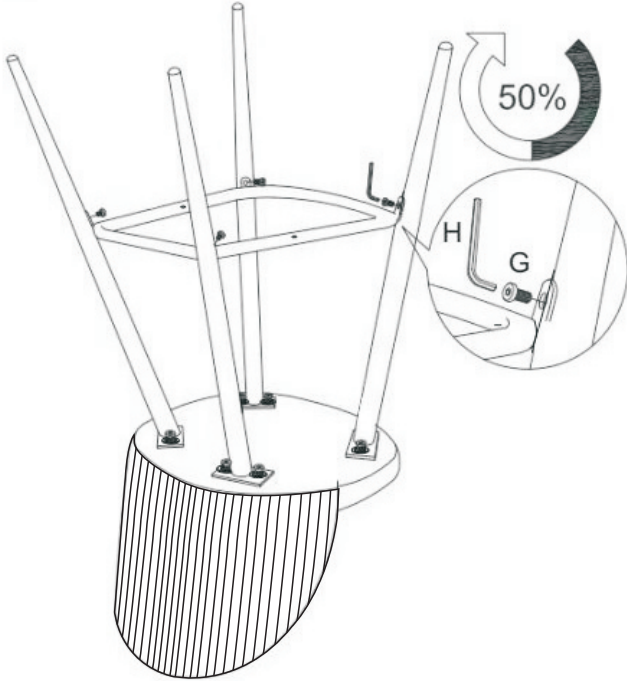

Step 3:



Step 4:



Care and Maintenance

- 1.Clean with your vacuum curtain attachment (the one with a lint-catching fabric strip) or a lint roller to stop dust build up.Do this regularly to keep the chair in its best condition.
- 2.Try to keep your chair away from direct sunlight, and not too close to heat sources, as this can cause fading over time.Do not allow the chair to make direct contact with any radiators or sources of heat.
- 3.Wipe up the spillages as quickly as possible by gently dabbing or blotting with a dry cloth until the mark fades away. Some tougher spills, such as oil and grease,can be more persistent and leave a stain. In this case, it's best to contact a specialist cleaning service.
- 4.Do not drag the chair. When moving, lift the chair off the floor.
- 5.Keep children and pets away while assembling the chair. Small parts could be a choking hazard.
- 6.Re-tighten all nuts and bolts after two weeks of use and regularly thereafter.
- 7.Do not sit on the arms of the chair.
- 8.Do not jump on the chair.
- 9.Only use the chair on a flat and level surface.
- 10.Dispose of all packaging carefully and responsibly - recycle where possible.
- 11.This product is intended for domestic use only, not commercial purposes.

Important

Assembly Tip

Before you begin, it's best to identify all of the parts and fittings to build your chair. We advise laying these out on the floor to check you have everything, and to familiarise your-self with all of the parts and fittings before building.

Top Tip

We recommend that you build your new chair in the room you'd like it to be located. This will help prevent any risk of damage to the frame whilst moving it.

Safety and Care

It's important to ensure children and animals are kept away from the assembly area.As there are small components used in this product which could present a choking hazard.All plastic and wrapping materials should also be kept away from children and animals to prevent any risk of suffocation.

Help and Support

Please contact our customer service team on 0113 519 0311 if you have any questions or issues with your purchase.

Recycling

Please ensure that packaging is disposed of in a safe and environmentally friendly way, and recycle where possible.Please keep your assembly instructions safe to refer back to in the future.