

DUSK.COM

LIVING | BEDROOM | DINING

Range Name: Gracie

Box dimensions: L129xW48xH78(cm)

Large Sideboard 2 Doors

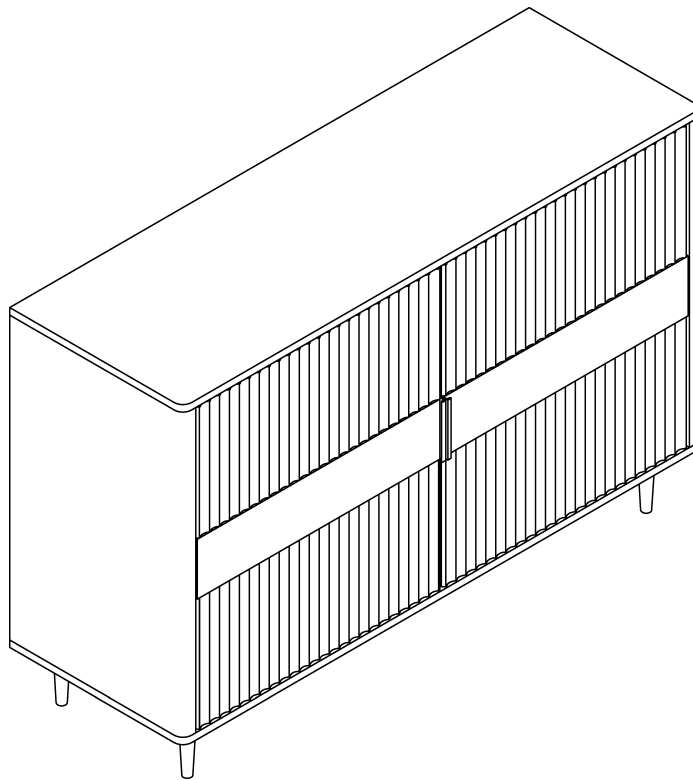

**THIS INSTRUCTION BOOKLET CONTAINS IMPORTANT SAFETY INFORMATION.
PLEASE READ AND KEEP FOR FUTURE REFERENCE.**



30 minutes approx
assembly time

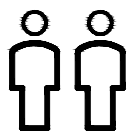

Two adults
assembly required

This product is intended for domestic use only, not for commercial purposes.

Page 1

Important

Assembly Tip

Before you begin, we advise laying everything out on a clean and soft level surface to avoid damaging the unit or your floor. It's best to identify all of the parts and fittings to build your sideboard, and to familiarise yourself with all of the parts and fittings before building.

Top Tip

We recommend that you build your new sideboard in the room you'd like it to be located. This will help prevent any risk of damage to the product whilst moving it.

Safety and Care

1. It's important to ensure children and animals are kept away from the assembly area, as there are small components used in this sideboard which could present a choking hazard. All plastic and wrapping materials should also be kept away from children and animals to prevent any risk of suffocation.
2. Do not stand on your product.
3. Always use the item on firm level ground, ensuring all legs remain in contact with the ground.
4. Do not set TV or other heavy objects on top of the product.
5. Children should always be under supervision whilst using this product. Never allow children to climb on the unit.
6. The installation of anti tipping kit to secure your furniture is strongly suggested.
7. Serious or fatal crushing injuries can occur from tipping furniture.

Help and Support

Please contact our customer service team on 0113 519 0311 if you have any questions or issues with your purchase.

Recycling

Please ensure that packaging is disposed of in a safe and environmentally friendly way, and recycle where possible. Please keep your assembly instructions safe to refer back to in the future.

Care and Maintenance

1. Only clean using a damp cloth, do not use bleach or abrasive cleaners as they may damage the finish over time.
2. Do not scrub or rub the surface when cleaning.
3. Do not use a very wet cloth or allow any liquid to contact with the veneer for a long period of time. Wipe any spillage immediately. Absorption can cause wood to warp or finishes to delaminate.
4. Do not drag the sideboard when moving, lift it off the floor instead.
5. Use a placemat or a coaster when putting hot items (e.g. hot drinks and dishes) on the wood surface.
6. It is not recommended to place the item next to sources of heat such as radiators, fires or directly exposed to sunlight. This may cause the wood to crack, split or fade due to the change of the humidity and temperature.
7. Wood will mellow and change colour over time, we recommend that ornaments and items placed on the surface to be moved regularly to prevent uneven mellowing.
8. Regularly check all fixings to ensure none have come loose. Re-tighten if necessary.
9. Avoid sharp items such as a screwdriver or any pointy tools.

Parts checklist

Please check you have all the parts listed below with your product:

Do not discard any of the packaging until you have checked that you have all the parts and the pack of fixings

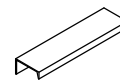
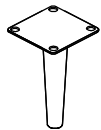
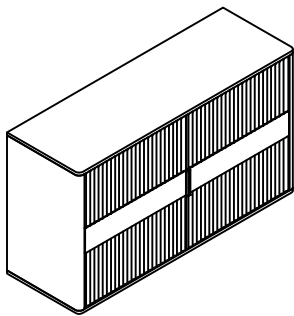

1 Large Sideboard 2 doors
x1pc









2 120mm Leg x4pcs

3 115mm Adjustable
Middle Leg x1pcs

4 120mm Handle x2pcs

Fittings checklist

Please check you have all the fittings listed below with your product:

 <p>A M6*15mm Bolt 20pcs+1pc extra</p>	 <p>B M6*14mm Washer 20pcs + 1pc extra</p>	 <p>C M6*10mm Spring washer 20pcs+1pc extra</p>
 <p>D M6 Allen Key 1pc</p>	 <p>E Plastic Bracket 4pcs</p>	 <p>F M3.5*20mm Screw 4pcs</p>
 <p>G M4*40mm Screw 4pcs</p>	 <p>H 37mm Wall Plug 4pcs</p>	 <p>I 250mm Nylon Strap 2pcs</p>

Bolt Length Ruler:

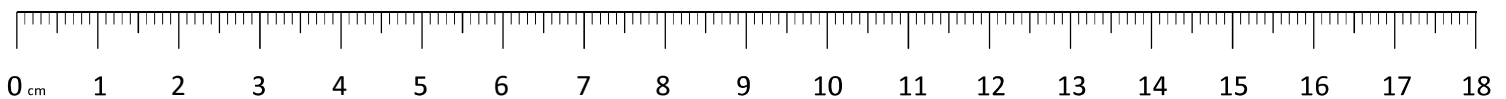



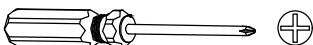

Tool required:



Crosshead Screwdriver (not provided)

Step 1: Attaching the legs to the bottom of large sideboard 2 doors.

- A**  20pcs
- B**  20pcs
- C**  20pcs
- D**  1pc

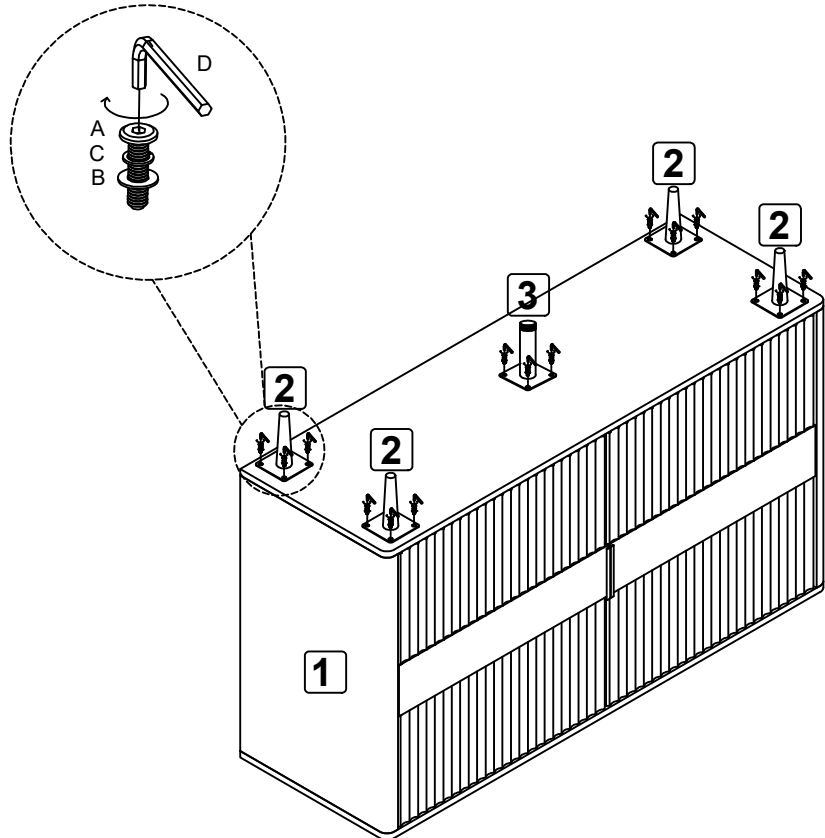

Step 2: Pull out the door with string. Disassemble the screws and attach the handle as shown in the figure.

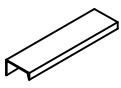
- 4**  2pcs

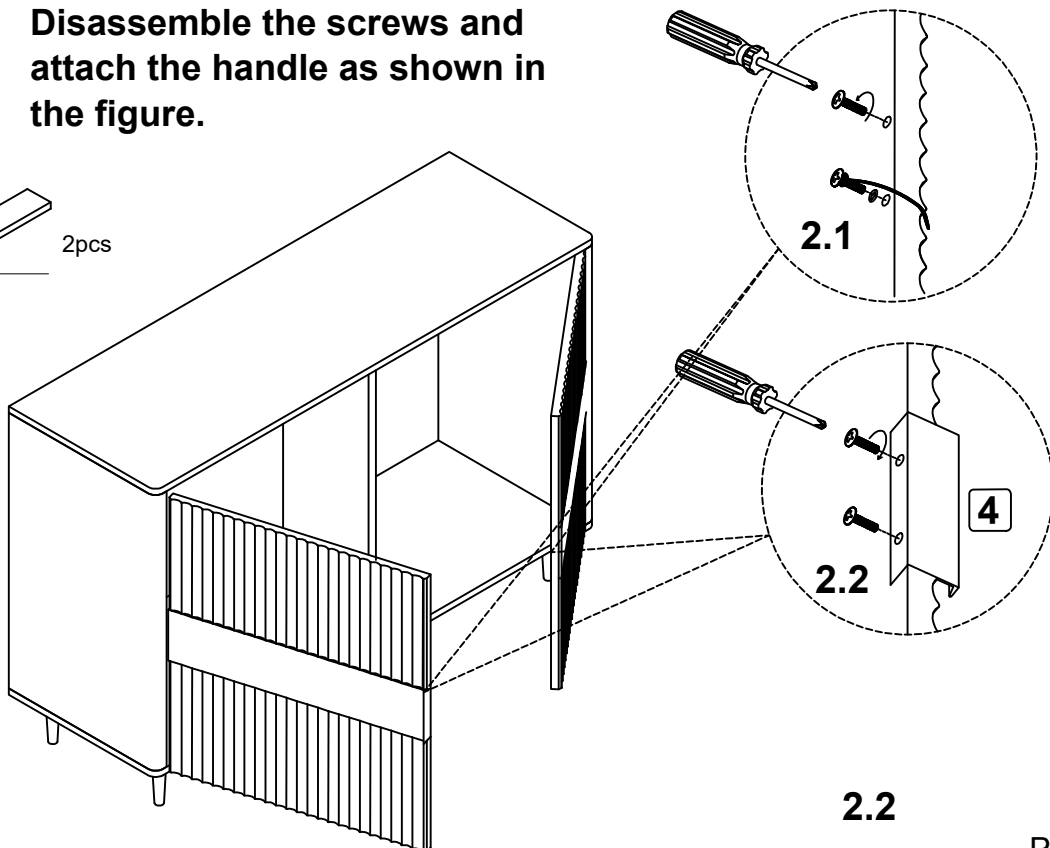

Center Legs are adjustable to touch the floor.

Step 3: Anti Tipping Kit Installation on the item.

E  2pcs

F  4pcs

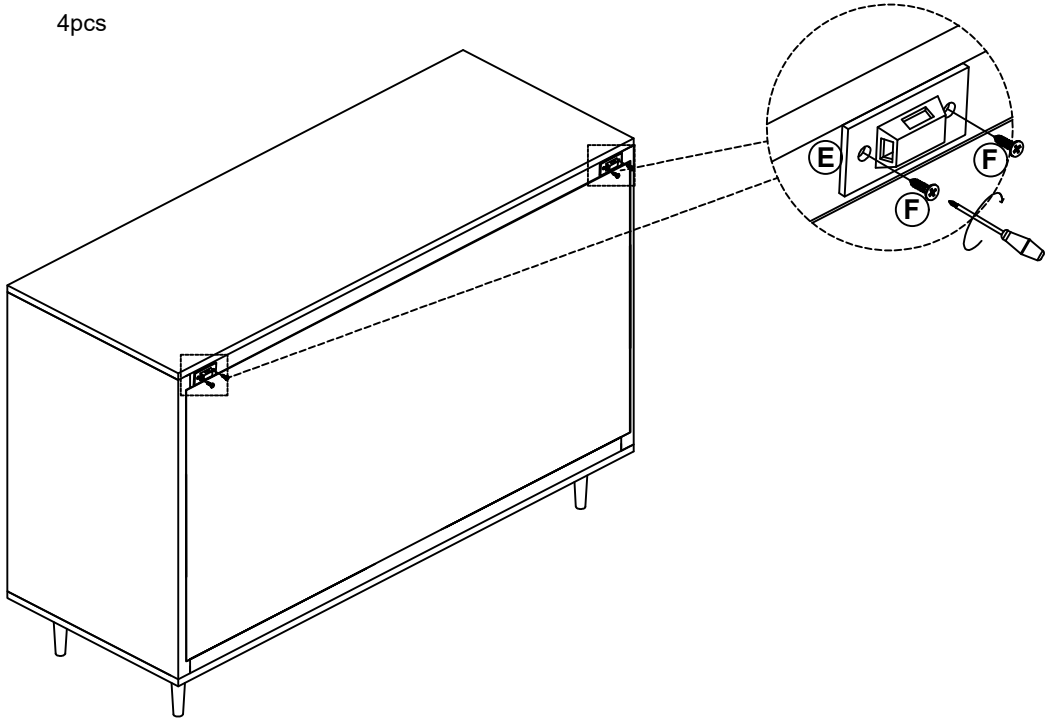

Step 4: Anti Tipping Kit Installation on the wall.

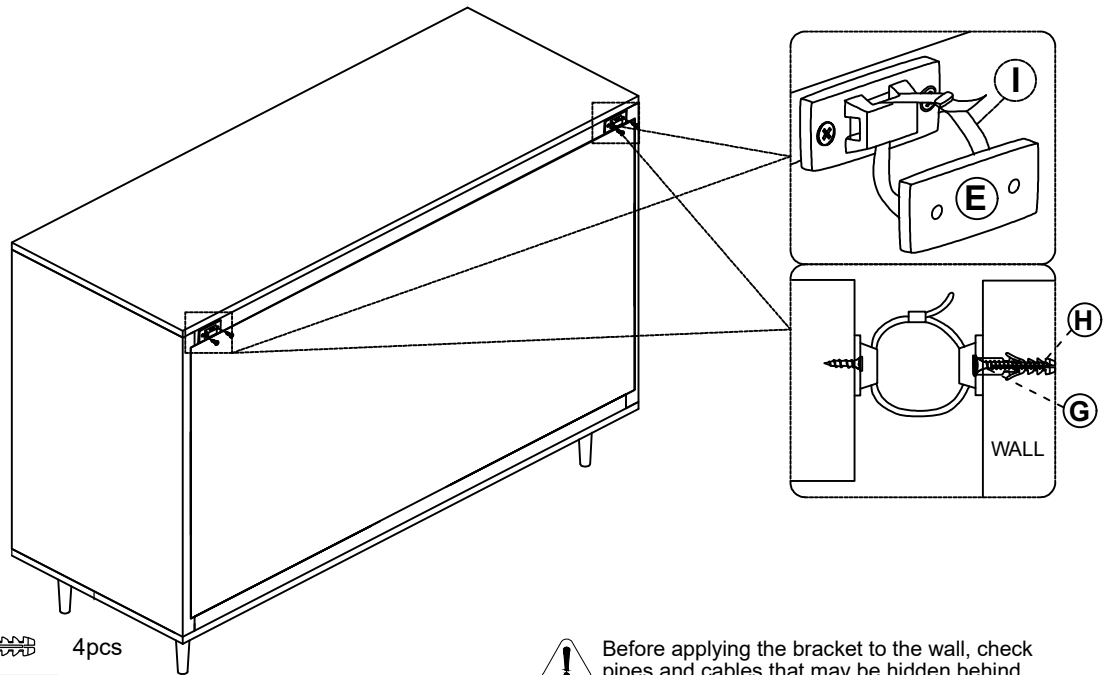

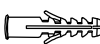
H  4pcs

E  2pcs

G  4pcs

I  2pcs

 Before applying the bracket to the wall, check pipes and cables that may be hidden behind.

WARNING: Manufacturer assumes no liability for improper installation or excessive loads placed on screws or bracket. This wall anchor is not a substitute for proper adult supervision.