

DUSK.COM
LIVING | BEDROOM | DINING

Range Name : EVIE
Box dimensions : 162x54x18.5cm

Evie TV Unit

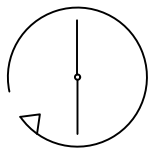
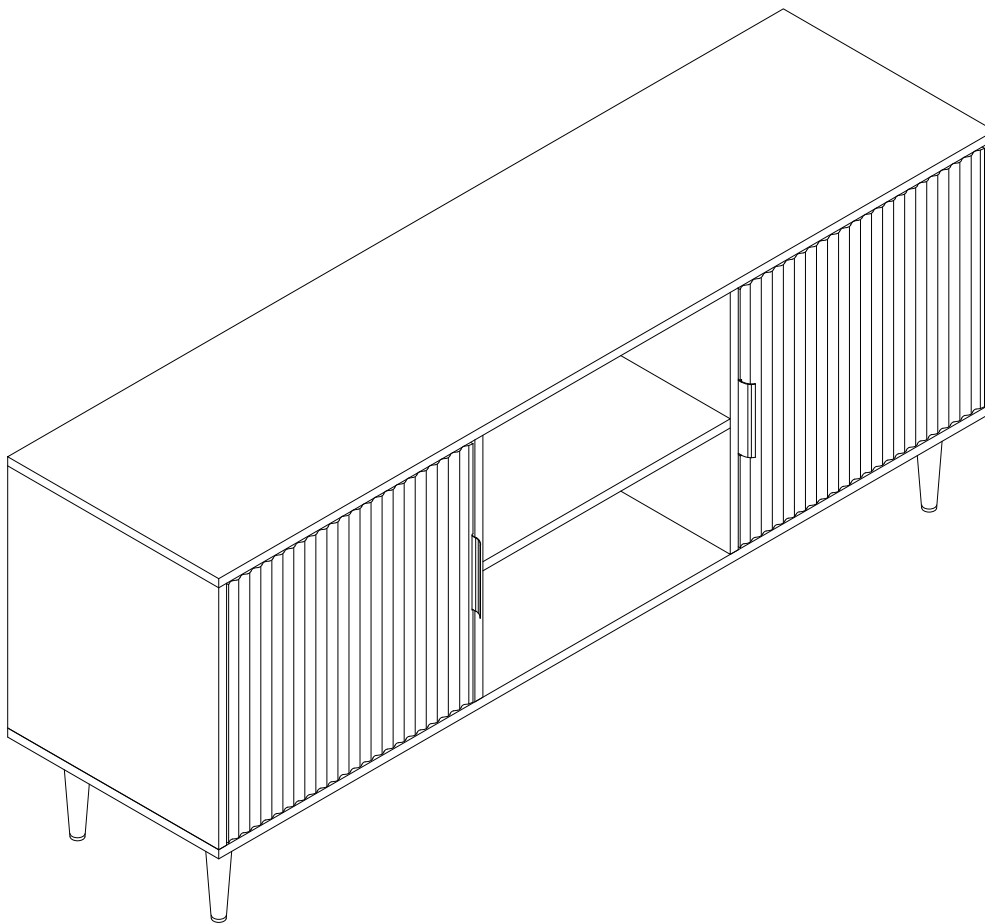

Up to 30 minutes
assembly time

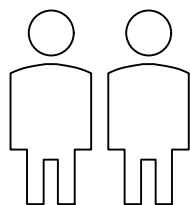

Two person
assembly

This product is intended for domestic use only, not for commercial purposes.

IMPORTANT

ASSEMBLY TIP

Before you begin, it's best to identify all of the parts and fittings to build your Evie TV Unit frame. We advise laying these out on the floor to check you have everything, and to familiarise yourself with all of the parts and fittings before building.

TOP TIP

We recommend that you assemble the Evie TV Unit in the room you'd like it to be located. This will help prevent any risk of damage to the frame whilst moving it.

SAFETY AND CARE

It's important to ensure children and animals are kept away from the assembly area, as there are small components used in this product which could present a choking hazard. All plastic and wrapping materials should also be kept away from children and animals to prevent any risk of suffocation.

HELP AND SUPPORT

Please contact our customer service team on 0113 519 0311 if you have any questions or issues with your purchase.

RECYCLING

Please ensure that packaging is disposed of in a safe and environmentally friendly way, and recycle where possible. Please keep your assembly instructions safe to refer back to in the future.

CARE AND MAINTENANCE:

1. Only clean using a damp cloth, do not use bleach or abrasive cleaners as they may damage the finish over time.
2. Do not use a very wet cloth or allow any liquid to contact with the veneer for a long period of time. Wipe any spillage immediately. Absorption can cause wood to warp or finishes to de-laminate.
3. Do not scrub or rub the surface when cleaning.
4. Do not drag the Evie TV Unit when moving, lift it off the floor instead.
5. Use a placemat or a coaster when putting hot items (e.g. hot drinks and dishes) on the wood surface.
6. It is not recommended to place the item next to sources of heat such as radiators, fires or directly exposed to sunlight. This may cause the wood to crack, split or fade due to the heat and humidity.
7. Wood will mellow and change colour over time, we recommend that ornaments and items placed on the surface to be moved regularly to prevent uneven mellowing.
8. Regularly check all fixings to ensure none have come loose. Re-tighten if necessary.
9. Avoid sharp items such as a screwdriver or any pointy tools.
10. Dispose of all packaging carefully and responsibly - recycle where possible.

Parts list











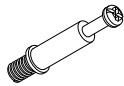



Before you begin building your Willow Bedside, please take a moment to read through the instructions and make sure that you have all the relevant parts listed on the parts check list.

Part Number	Part Description	Quantity
①	Left Side Panel	1pc
②	Left Middle Panel	1pc
③	Right Middle Panel	1pc
④	Right Side Panel	1pc
⑤	Top	1pc
⑥	Leg	4pcs
⑦	Back Middle Panel	1pc
⑧	Shelf Panel	1pc
⑨	Bottom Panel	1pc
⑩	Centre Leg	1pc

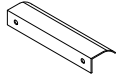
Part Number	Part Description	Quantity
⑪	Back Panel	2pcs
⑫	Left Door Panel	1pc
⑬	Right Door Panel	1pc

Fittings

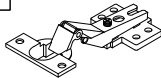
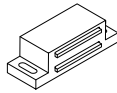
Please check you have all the fittings listed below with your product.

 <p>M6*35mm Bolt 12pcs+1pc extra</p>	 <p>Ø15x9.5mm Cam Lock 12pcs+1pc extra</p>	 <p>Ø8x30mm Dowel 20pcs+2pcs extra</p>	 <p>M3.5*12mm Screw 6pcs</p>	 <p>M3*14mm Screw 16pcs+1pc extra</p>
 <p>M6*35mm Screw 2pcs</p>	 <p>M5*40mm Screw 12pcs+1pc extra</p>	 <p>4mm Allen Key 1pc</p>	 <p>15x9mm Plastic Buckle 12pcs+1pc extra</p>	 <p>Handle 2pcs</p>
 <p>M4*14mm Screw 22pcs+2pcs extra</p>	 <p>Wall Bracket 2pcs</p>	 <p>Washer 2pcs</p>	 <p>Ø6x30mm Wall Plug 2pcs</p>	 <p>Hinge 4pcs</p>
 <p>Pusher 2pcs</p>	 <p>M4*14mm Screw 24pcs+2pcs extra</p>			

Parts list

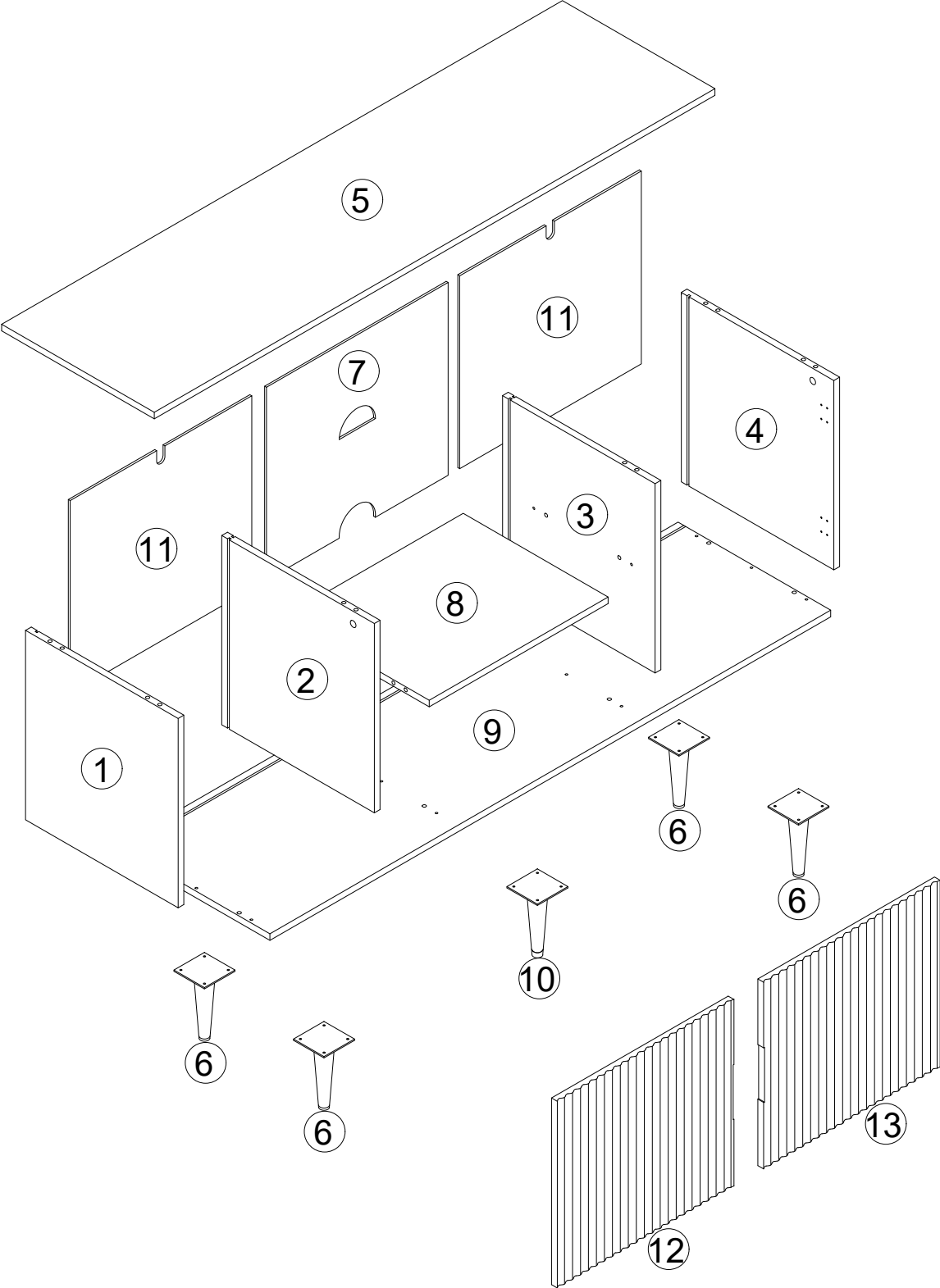

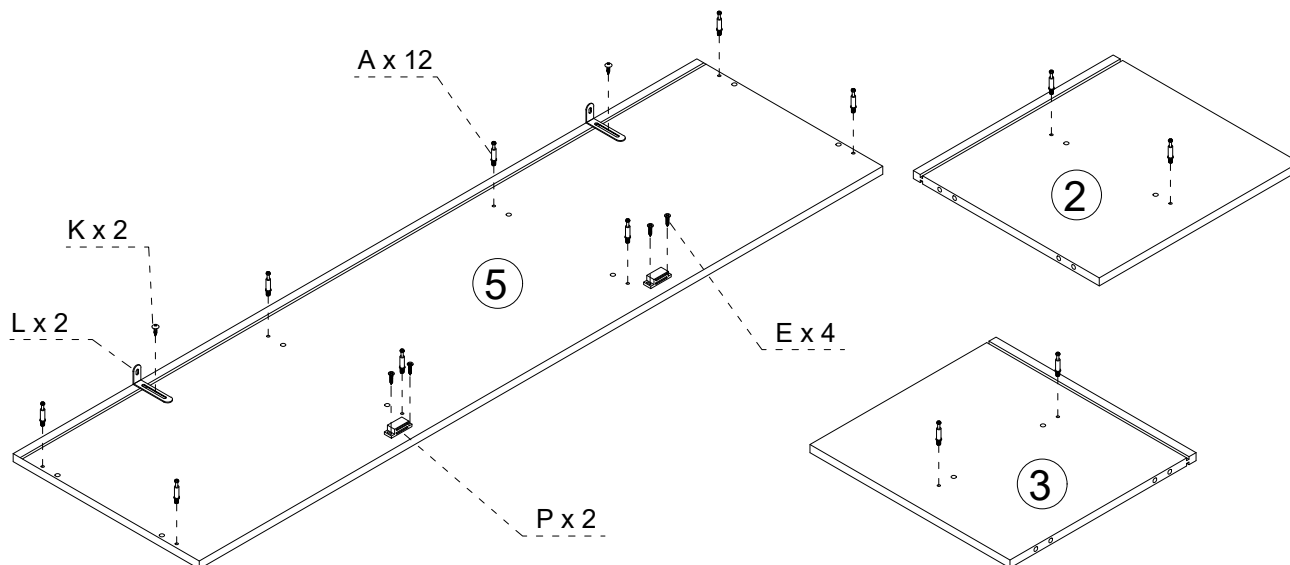

1. Attach parts to panels.

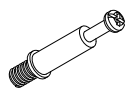

A	
M6*35mm Bolt 12pcs	

K	
M4*14mm Screw 2pcs	

L	
Wall Bracket 2pcs	

E	
M3*14mm Screw 4pcs	

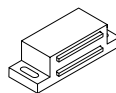
P	
Pusher 2pcs	

2. Attach shelf panel to middle panels.

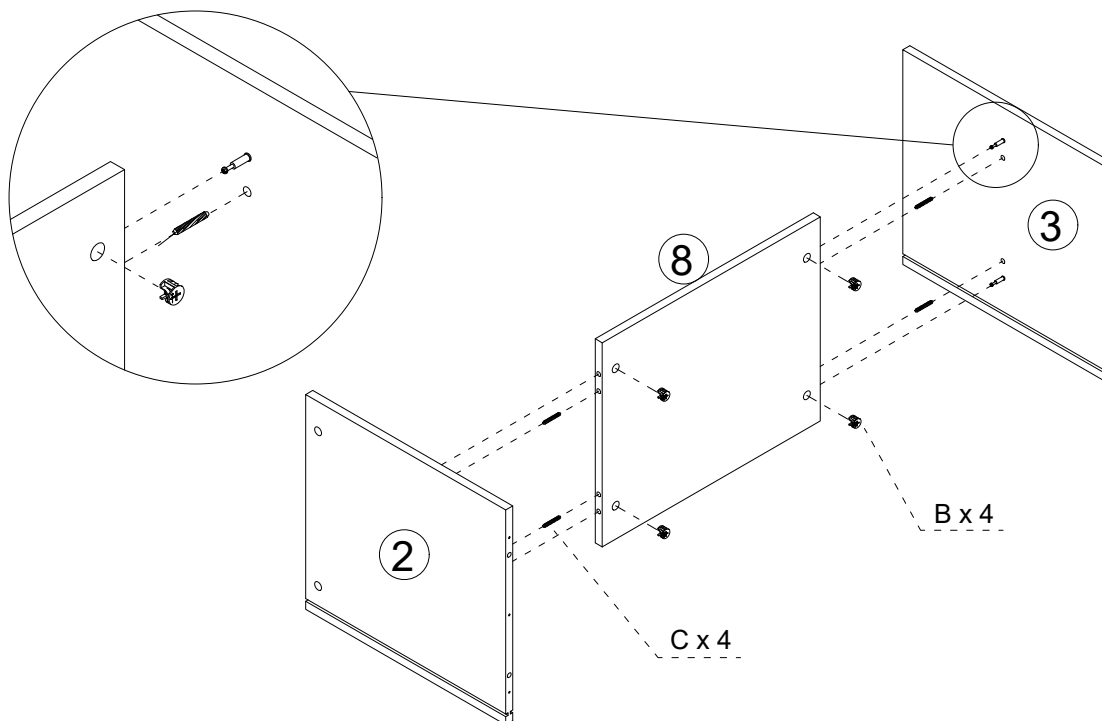



B	
Ø15x9.5mm Cam Lock 4pcs	

C	
Ø8x30mm Dowel 4pcs	

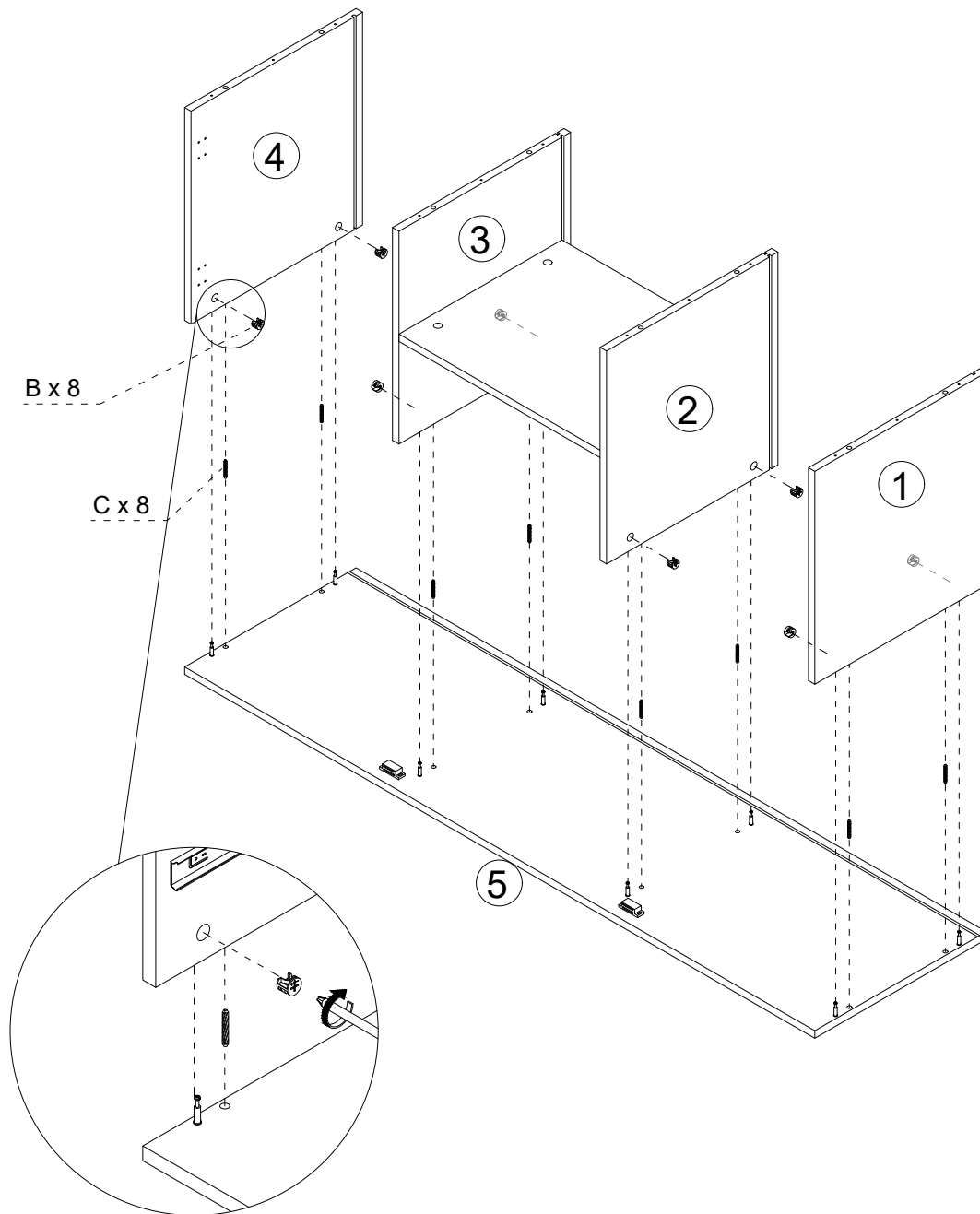
3. Attach panels to Top.



B	
Ø15x9.5mm Cam Lock	
8pcs	

C	
Ø8x30mm Dowel	
8pcs	

4.Assemble back panels.

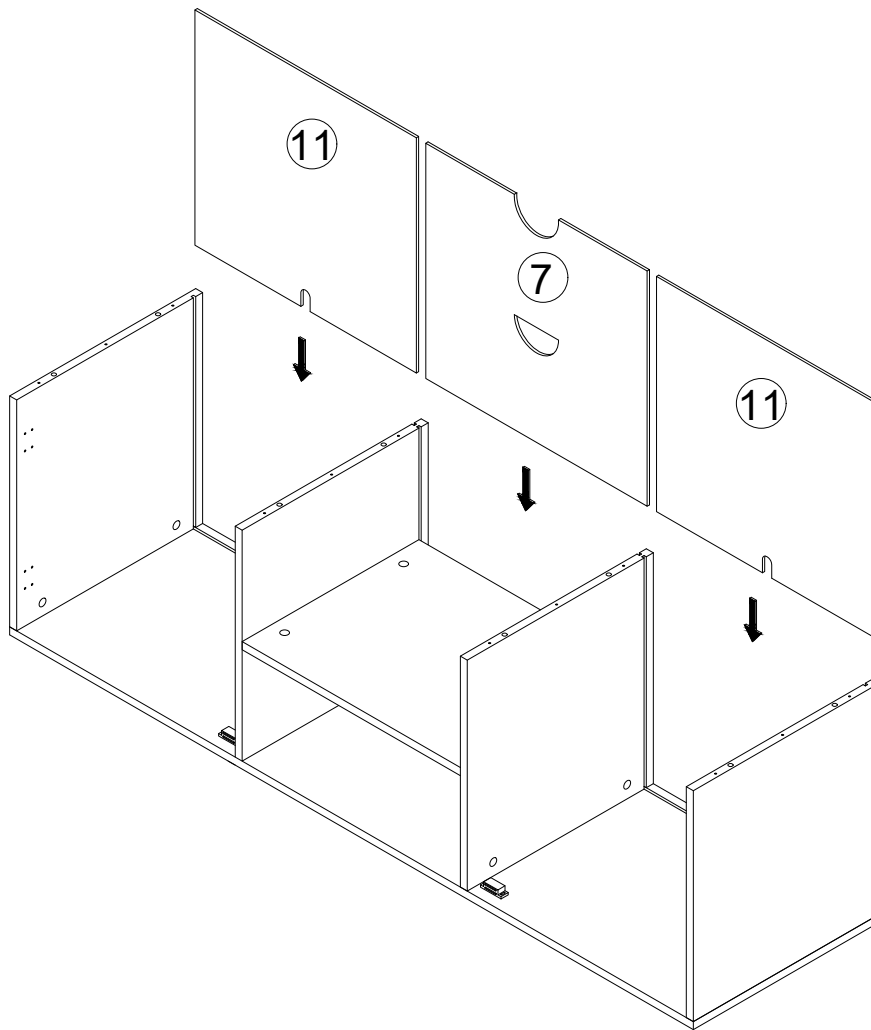

5. Attach bottom panel to the frame.

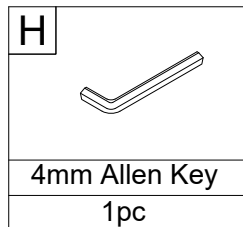
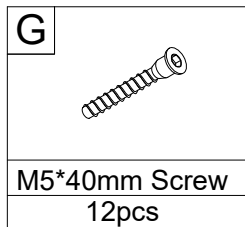
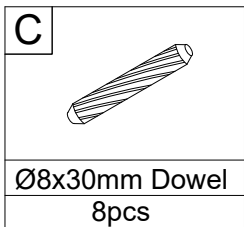
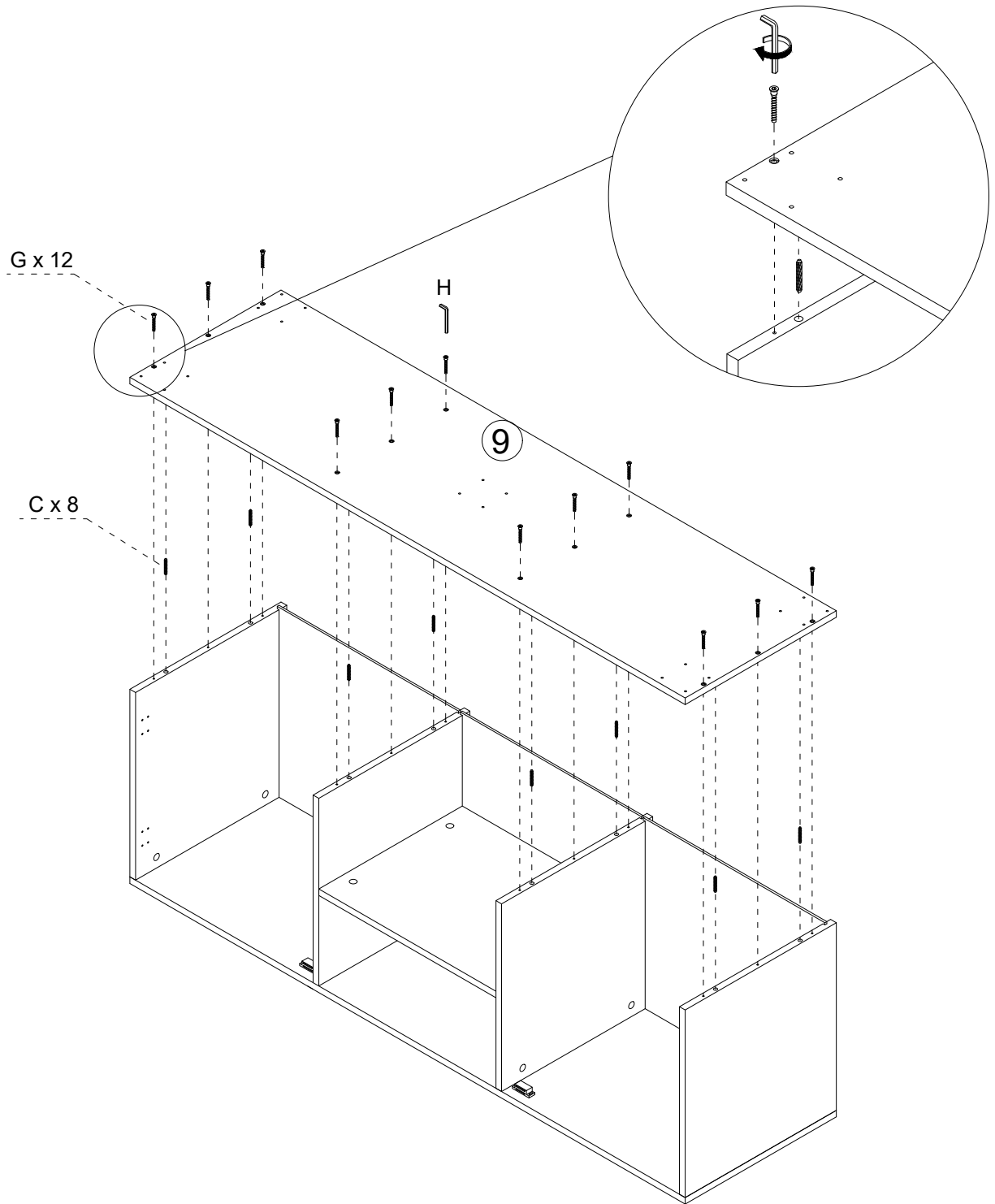

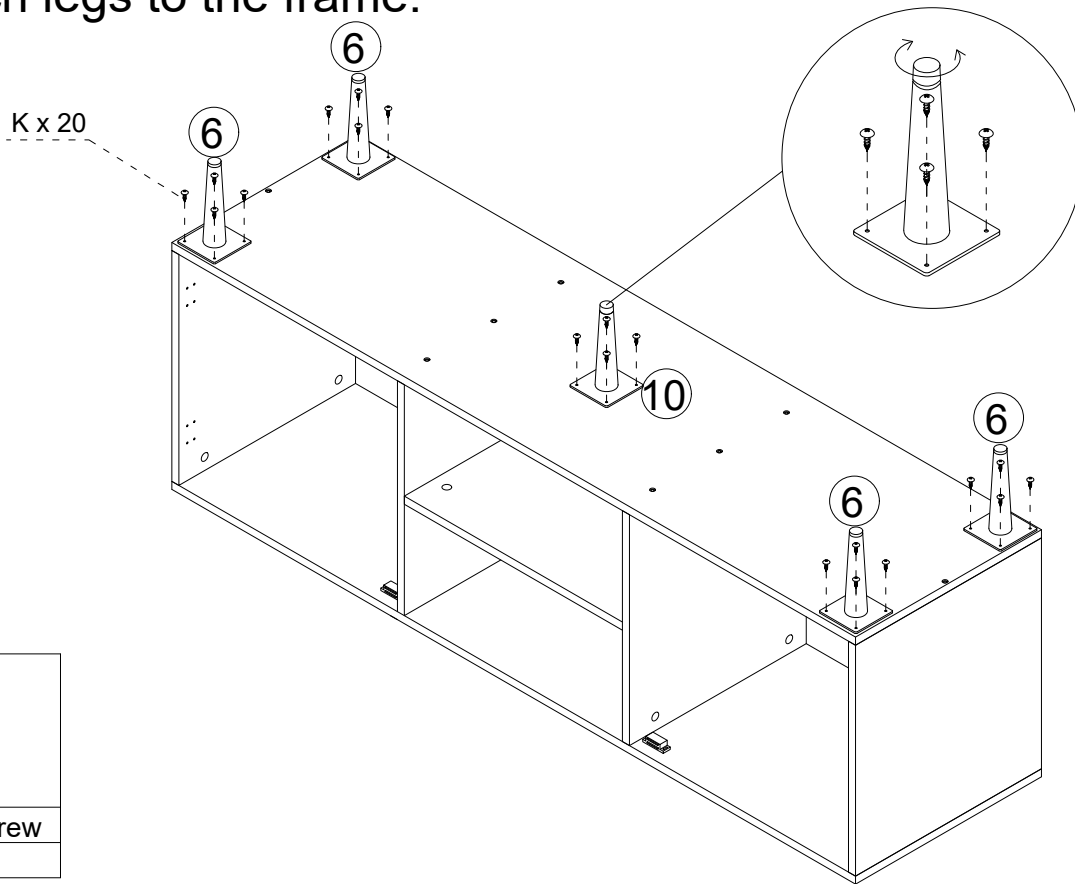

6. Attach legs to the frame.

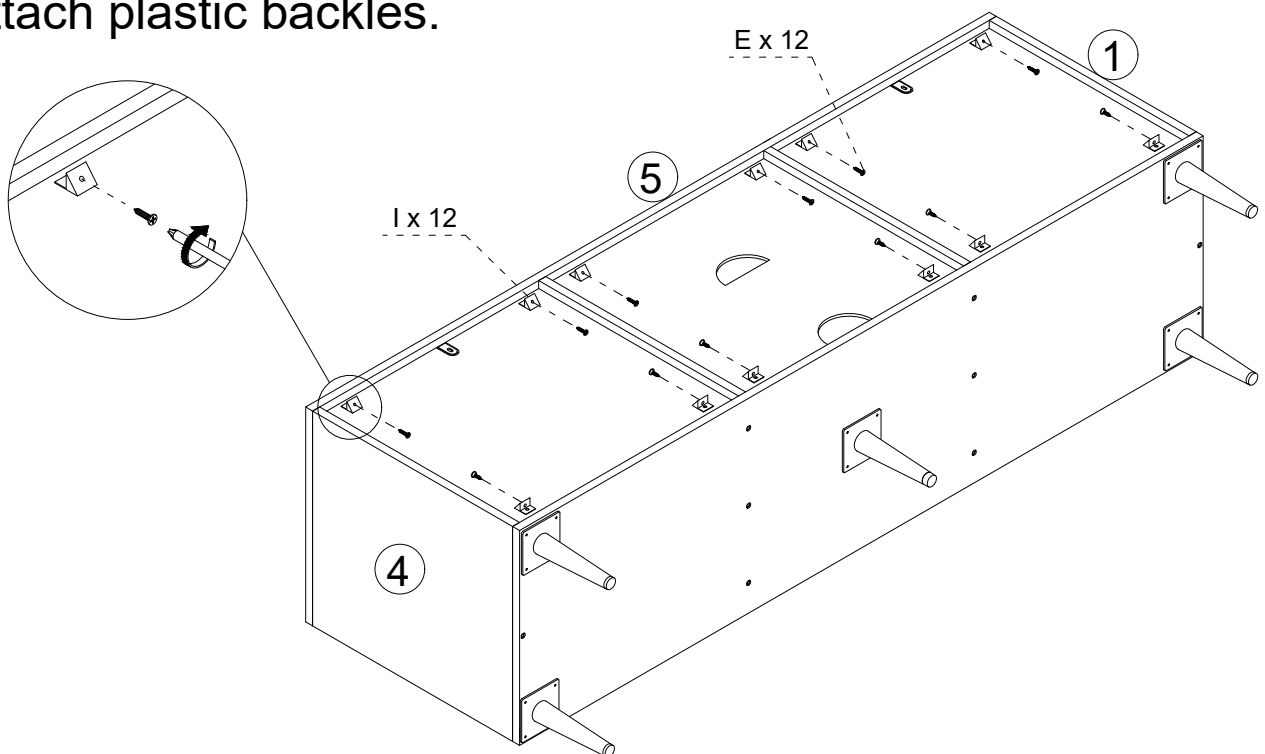

K	
M4*14mm Screw	
20pcs	

7. Attach plastic buckles.



E	
M3*14mm Screw	
12pcs	

I	
15x9mm Plastic Buckle	
12pcs	

8. Attach hinges to the door.

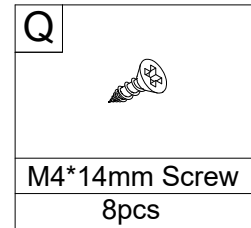
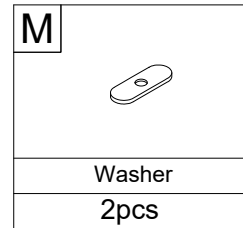
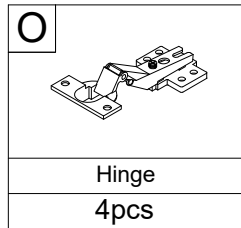
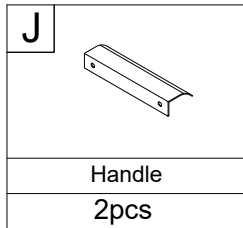
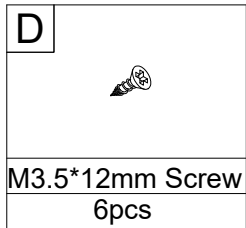
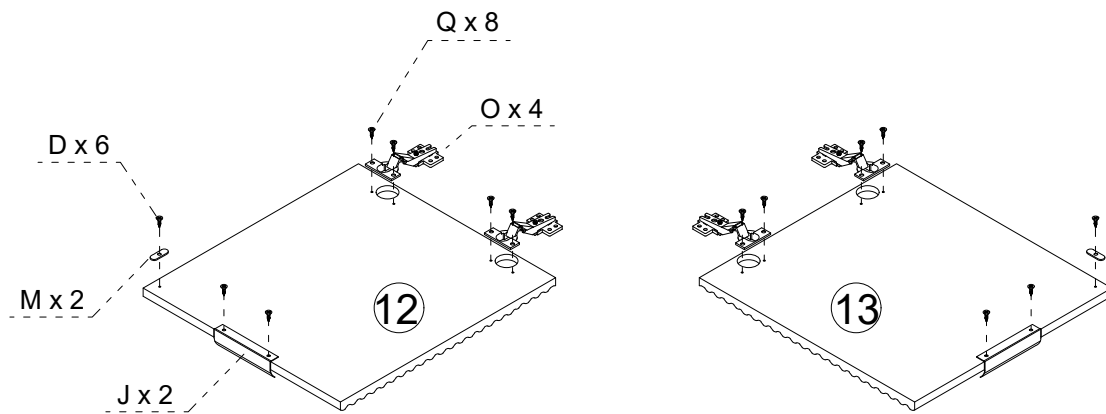

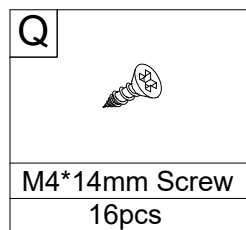
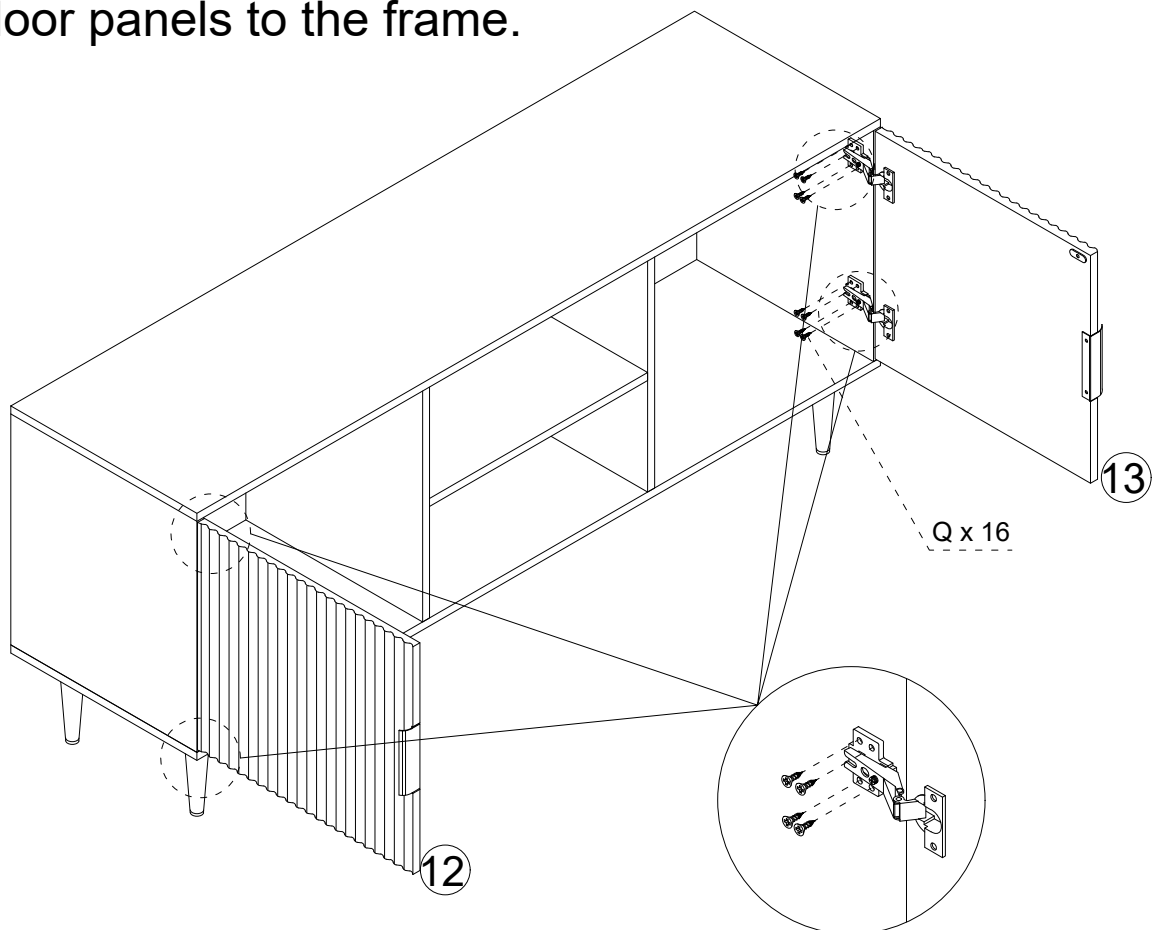

9. Attach door panels to the frame.

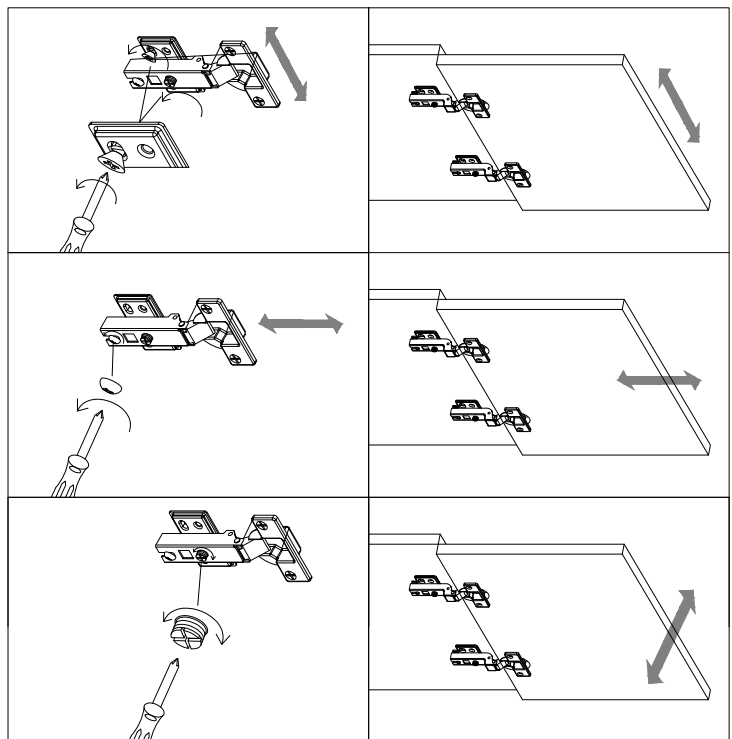
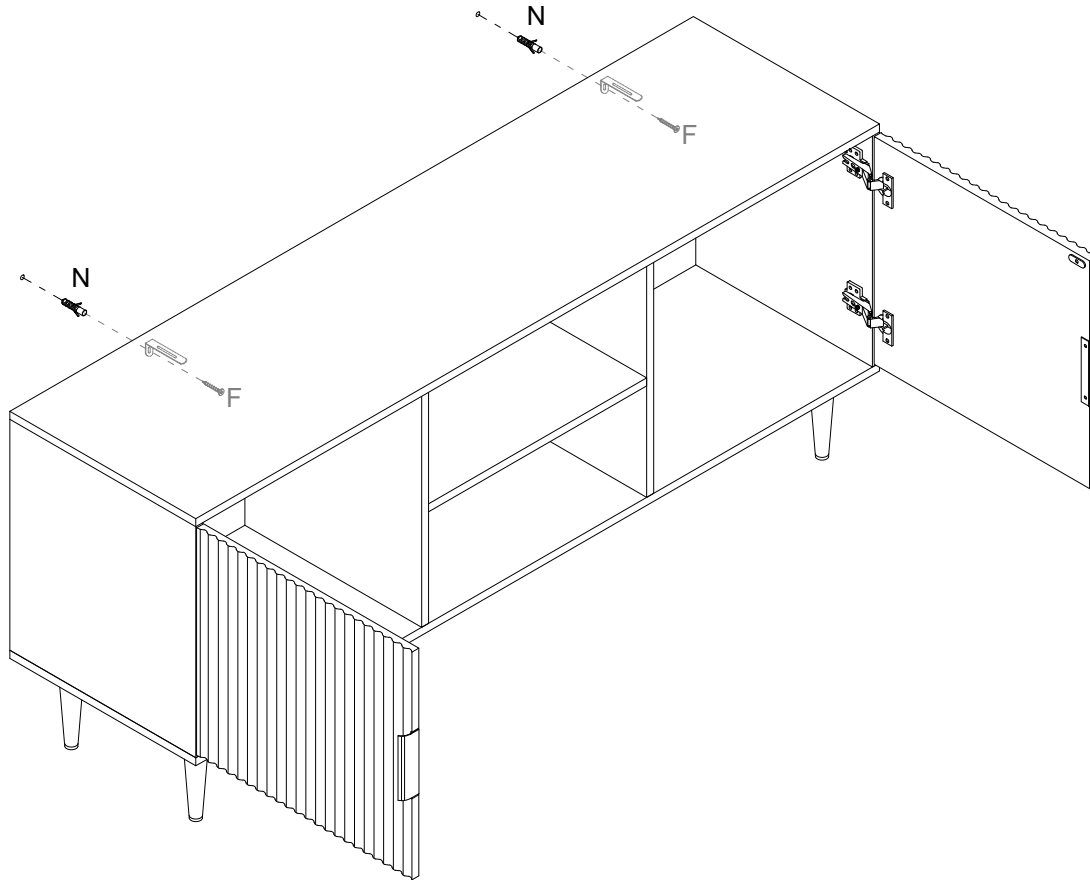

10. Fix the L-shaped Bracket to the wall.



F	
M6*35mm Screw	
2pcs	

N	
Ø6x30mm Wall Plug	
2pcs	