

DUSK.COM

LIVING | BEDROOM | DINING

Range Name : DORA

Box 1 dimensions : 177.5x65x11.5cm

Box 2 dimensions : 104x65x16cm

Dora 2 Door Wardrobe

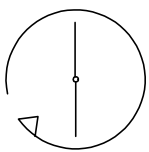
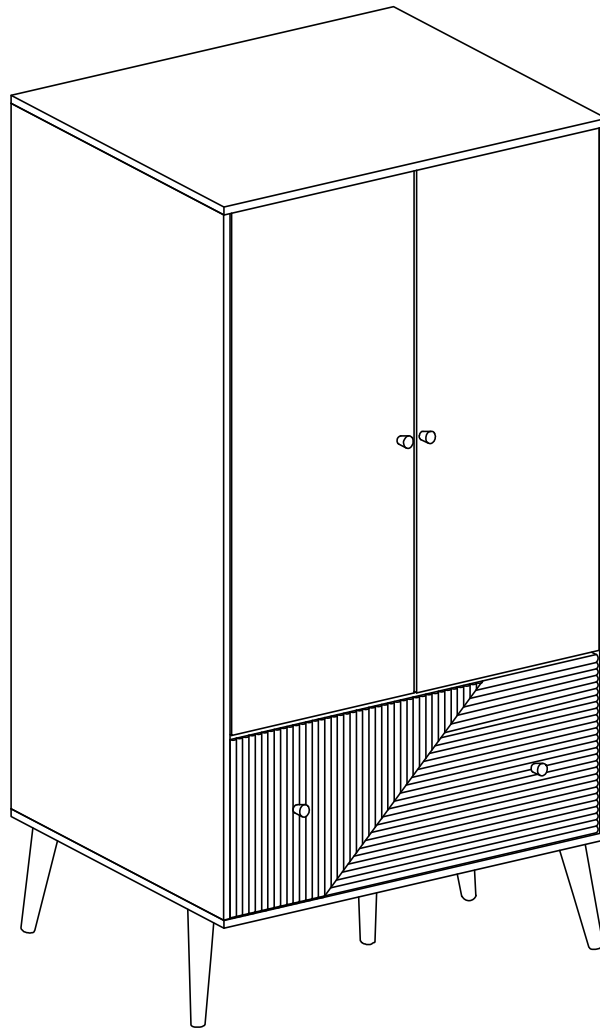

Up to 60 minutes
assembly time

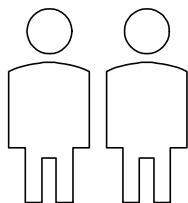

Two person
assembly

This product is intended for domestic use only, not for commercial purposes.

P-1-16

IMPORTANT

ASSEMBLY TIP

Before you begin, it's best to identify all of the parts and fittings to build your Dora Wardrobe frame. We advise laying these out on the floor to check you have everything, and to familiarise yourself with all of the parts and fittings before building.

TOP TIP

We recommend that you assemble the Dora Wardrobe in the room you'd like it to be located. This will help prevent any risk of damage to the frame whilst moving it.

SAFETY AND CARE

It's important to ensure children and animals are kept away from the assembly area, as there are small components used in this product which could present a choking hazard. All plastic and wrapping materials should also be kept away from children and animals to prevent any risk of suffocation.

HELP AND SUPPORT

Please contact our customer service team on 0113 519 0311 if you have any questions or issues with your purchase.

RECYCLING

Please ensure that packaging is disposed of in a safe and environmentally friendly way, and recycle where possible. Please keep your assembly instructions safe to refer back to in the future.

CARE AND MAINTENANCE:

1. Only clean using a damp cloth, do not use bleach or abrasive cleaners as they may damage the finish over time.
2. Do not use a very wet cloth or allow any liquid to contact with the veneer for a long period of time. Wipe any spillage immediately. Absorption can cause wood to warp or finishes to de-laminate.
3. Do not scrub or rub the surface when cleaning.
4. Do not drag the Dora Wardrobe when moving, lift it off the floor instead.
5. Use a placemat or a coaster when putting hot items (e.g. hot drinks and dishes) on the wood surface.
6. It is not recommended to place the item next to sources of heat such as radiators, fires or directly exposed to sunlight. This may cause the wood to crack, split or fade due to the heat and humidity.
7. Wood will mellow and change colour over time, we recommend that ornaments and items placed on the surface to be moved regularly to prevent uneven mellowing.
8. Regularly check all fixings to ensure none have come loose. Re-tighten if necessary.
9. Avoid sharp items such as a screwdriver or any pointy tools.
10. Dispose of all packaging carefully and responsibly - recycle where possible.

Parts list





Before you begin building your Dora Wardrobe, please take a moment to read through the instructions and make sure that you have all the relevant parts listed on the parts check list.

Part Number	Part Description	Quantity
①	Top	1pc
②	Bottom Panel	1pc
③	Left Side Panel	1pc
④	Right Side Panel	1pc
⑤	Shelf Panel	1pc
⑥	Centre Support	2pcs
⑦	Back Panel	3pcs
⑧	Back Panel	1pc
⑨	Drawer Front	1pc
⑩	Drawer Left Side	1pc

Part Number	Part Description	Quantity
⑪	Drawer Right Side	1pc
⑫	Drawer Back Side	1pc
⑬	Drawer Bottom	1pc
⑭	Drawer Floor	1pc
⑮	Door Panel	2pcs
⑯	Leg	4pcs
⑰	Centre Leg	1pc
⑱	Supporting metal tube	1pc
⑲	Centre Support	1pc

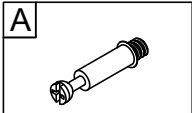
Fittings

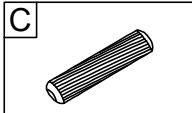
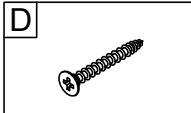
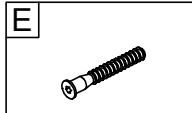
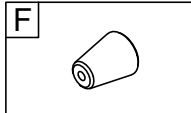
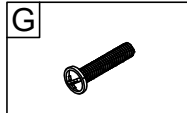
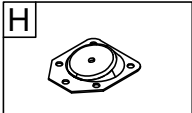
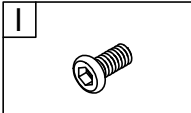
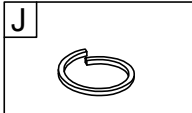
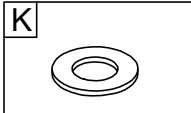
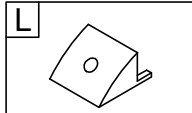
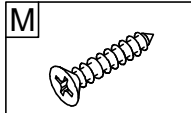
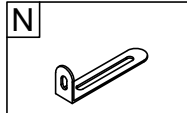
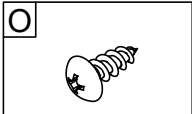
Please check you have all the fittings listed below with your product.

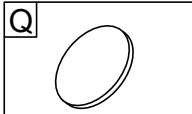
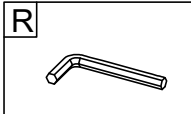
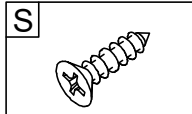
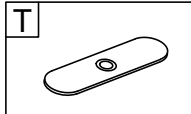
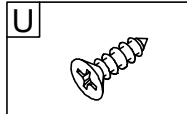
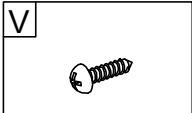
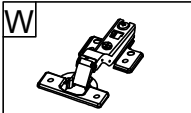
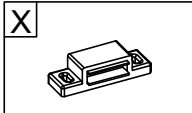
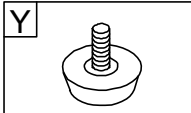
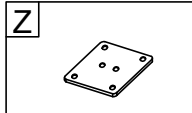
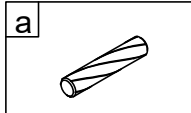
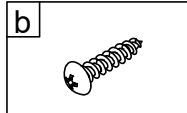
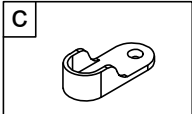
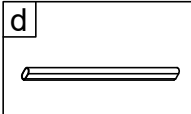
 M6*35mm Bolt 25pcs+3pcs extra	 Ø15x9.5mm Cam Lock 25pcs+3pcs extra	 Ø8x30mm Dowel 12pcs+1pc extra	 Ø4x35mm Screw 8pcs+1pc extra	 Ø7x40mm Screw 6pcs	 Handle 4pcs	 M4*18mm Bolt 4pcs
 Metal Plate 4pcs	 M6*14mm Bolt 24pcs+3pcs extra	 Spring Washer 24pcs+3pcs extra	 Lock Washer 24pcs+3pcs extra	 Plastic Buckle 16pcs+2pcs extra	 Ø3x16mm Screw 16pcs+2pcs extra	 Wall Bracket 2pcs
 Ø4x14mm Screw 6pcs	 Wall Plug 2pcs	 Cover 8pcs+1pc extra	 4mm Allen Key 1pc	 Ø4x14mm Screw 36pcs+3pcs extra	 Washer 4pcs	 Ø3x12mm Screw 8pcs+1pc extra
 Ø3x14mm Screw 4pcs	 Hinge 6pcs	 Pusher 2pcs	 Adjustable foot pads 1pc	 Metal Plate 1pc	 Ø6x30mm Dowel 1pc	 Ø4x30mm Screw 2pcs
 Clothes Tray 2pcs	 Clothes poles 1pc					

Parts list

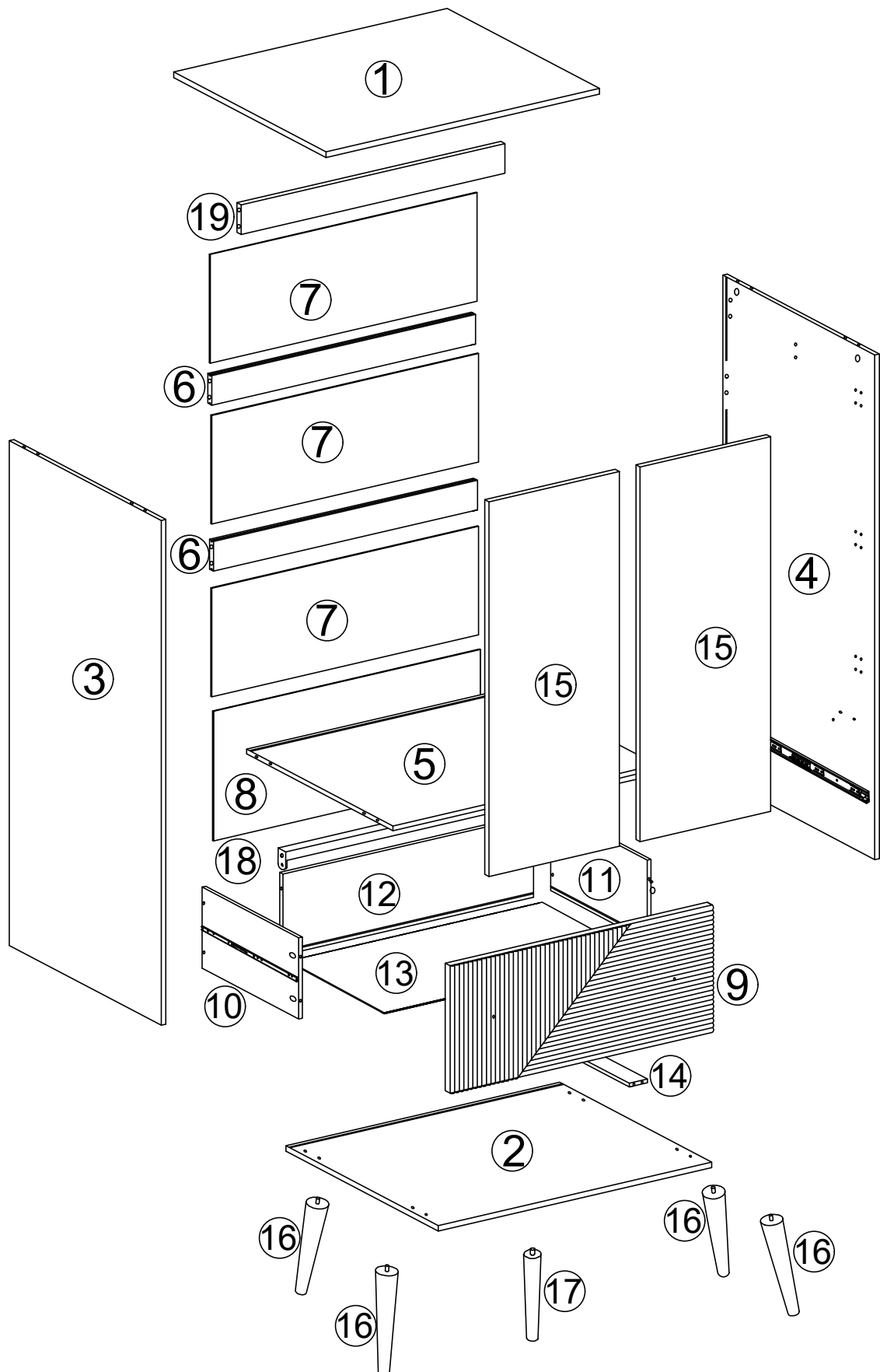

1. Attach parts to the top panel.

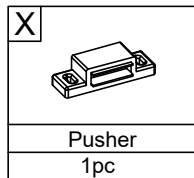
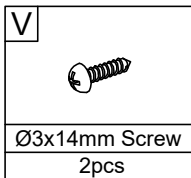
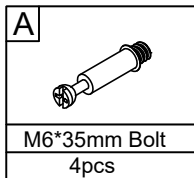
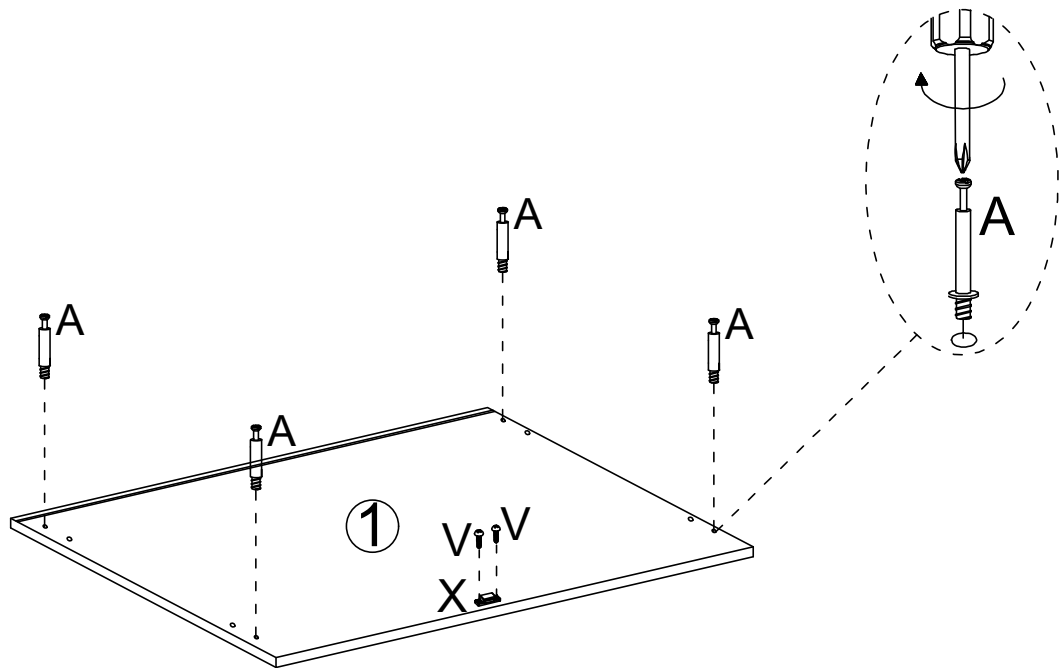

2. Attach parts to the side panel.

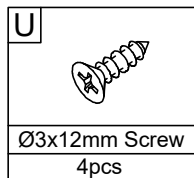
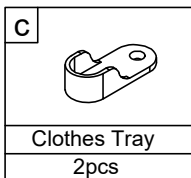
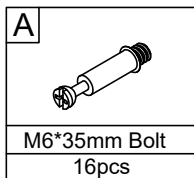
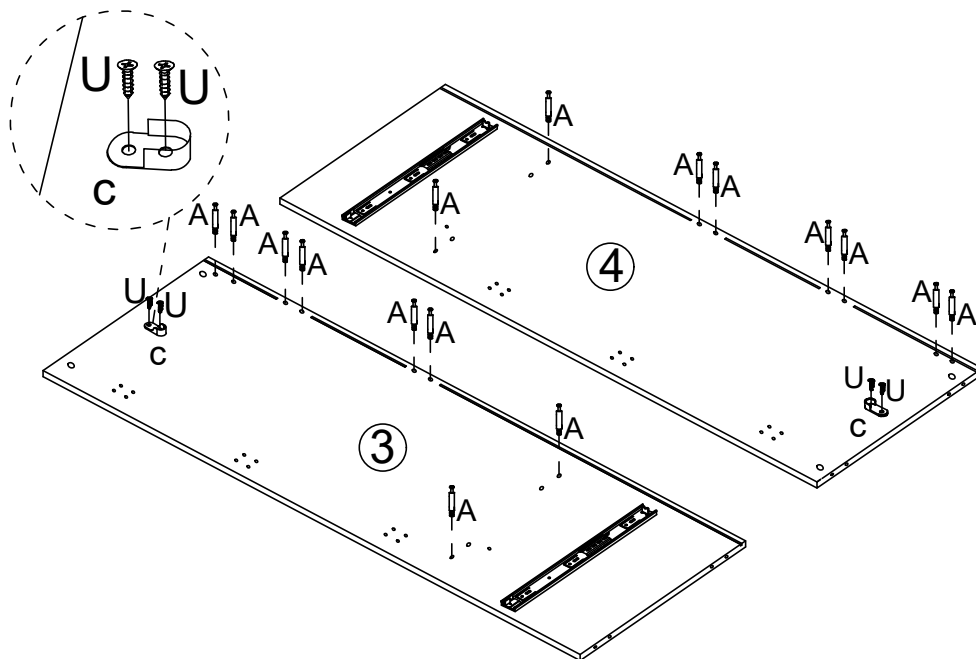

3. Attach supporting metal tube and pusher to the shelf panel.

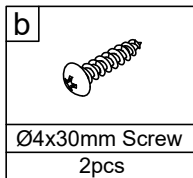
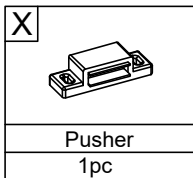
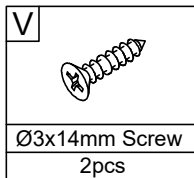
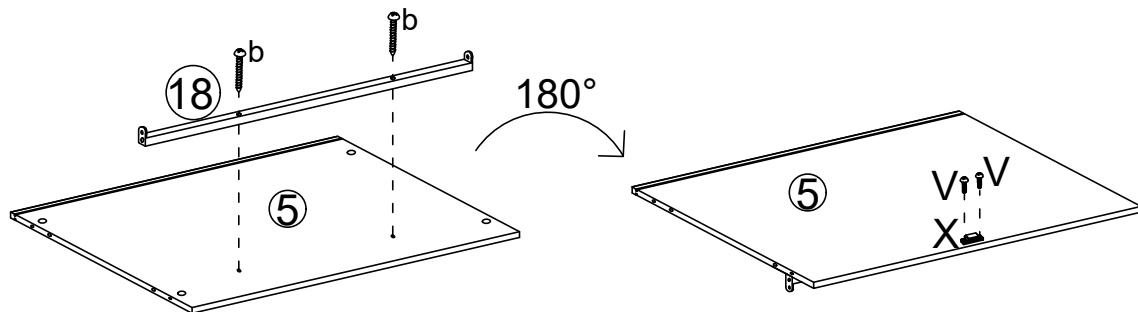

4. Attach center support and shelf panel to the right side panel.

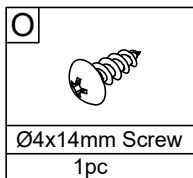
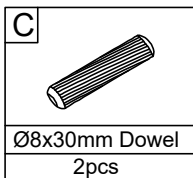
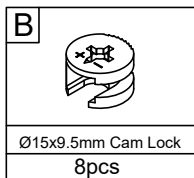
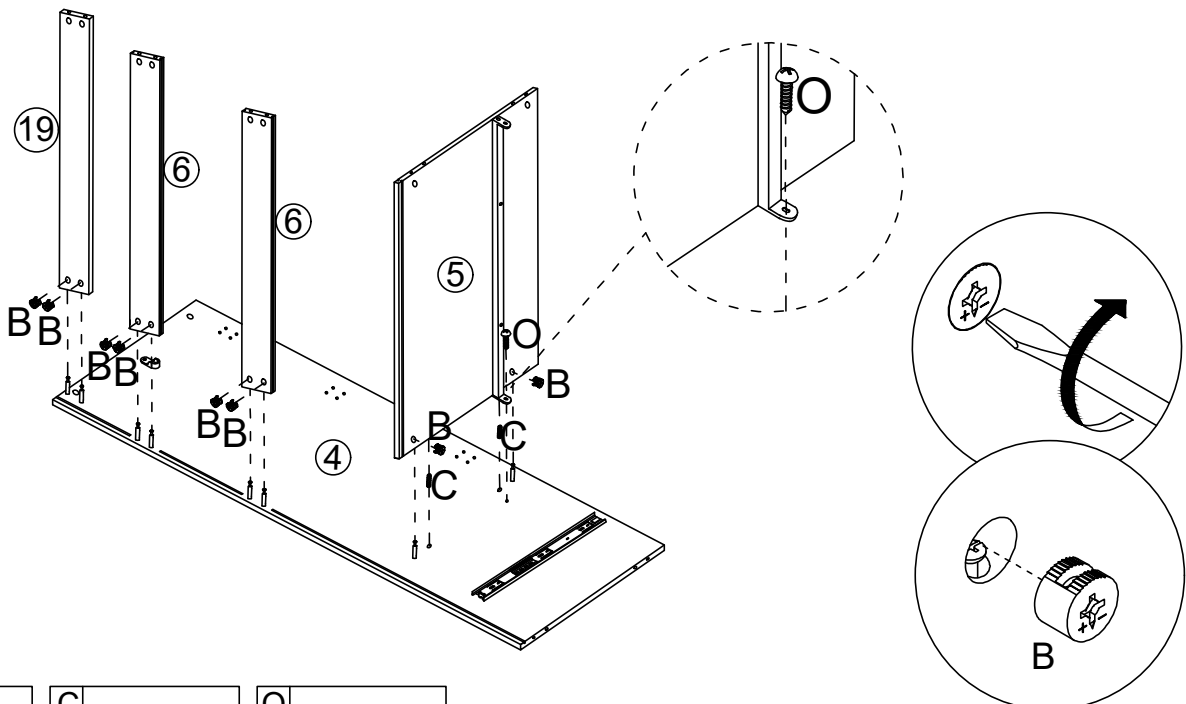

5. Assemble the back panel.

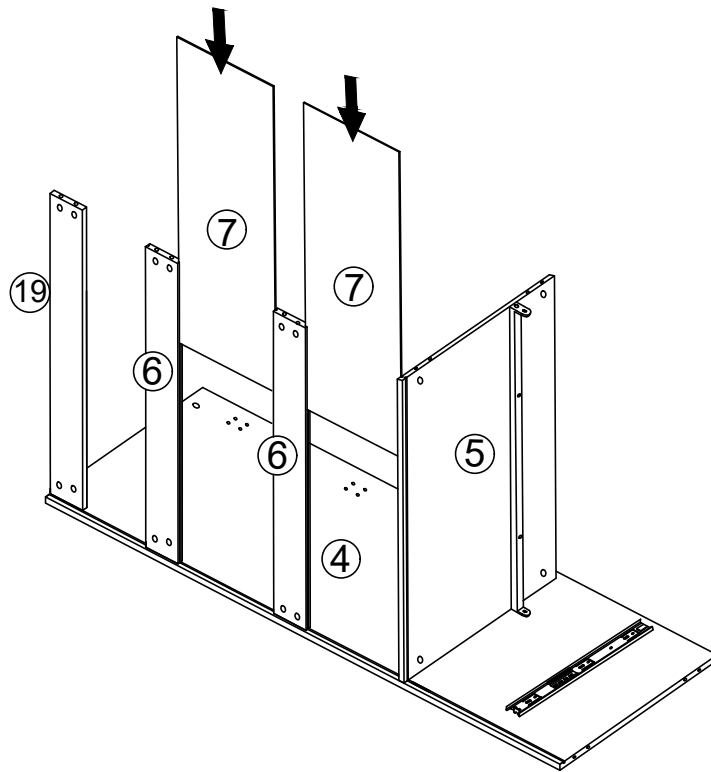

6. Attach the left side panel to the frame.

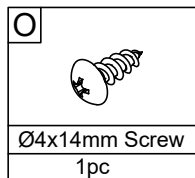
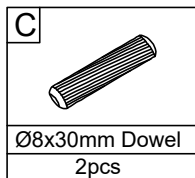
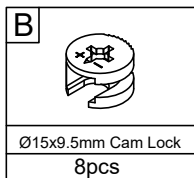
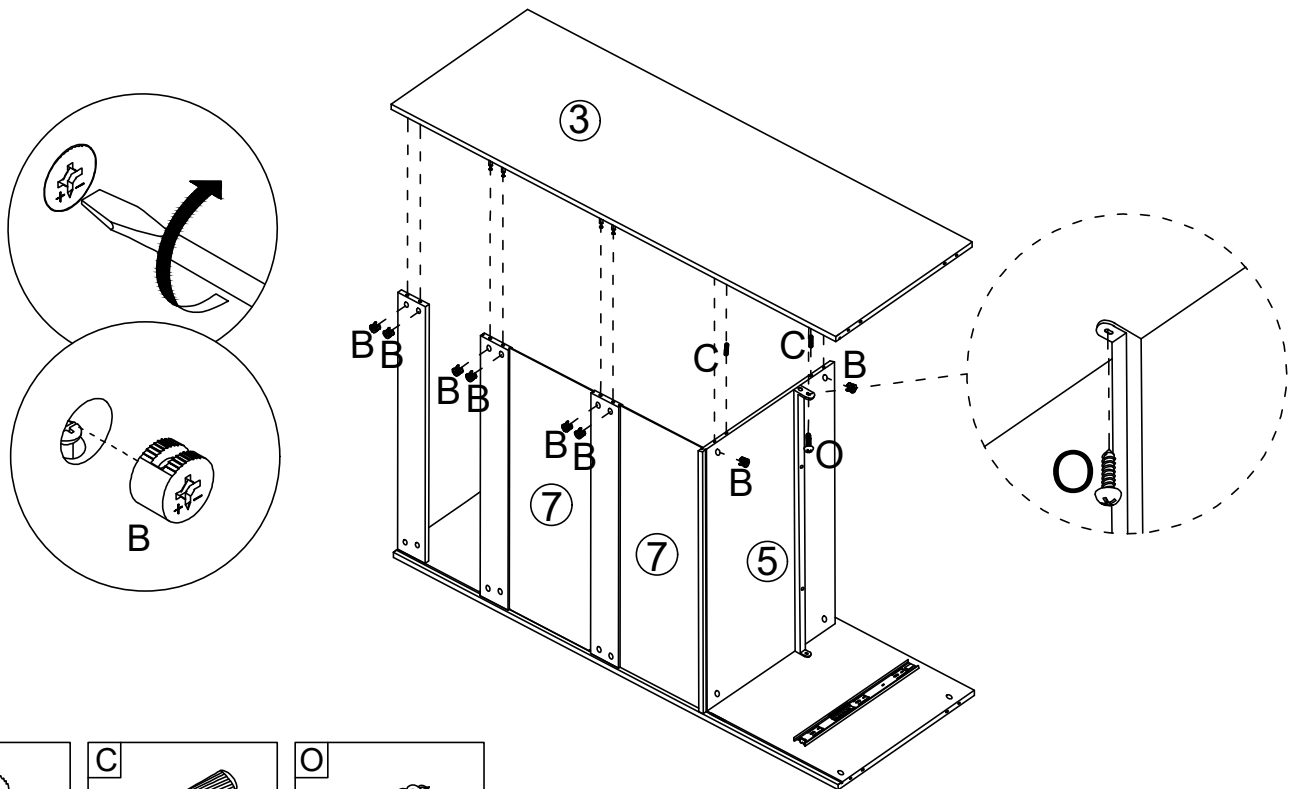



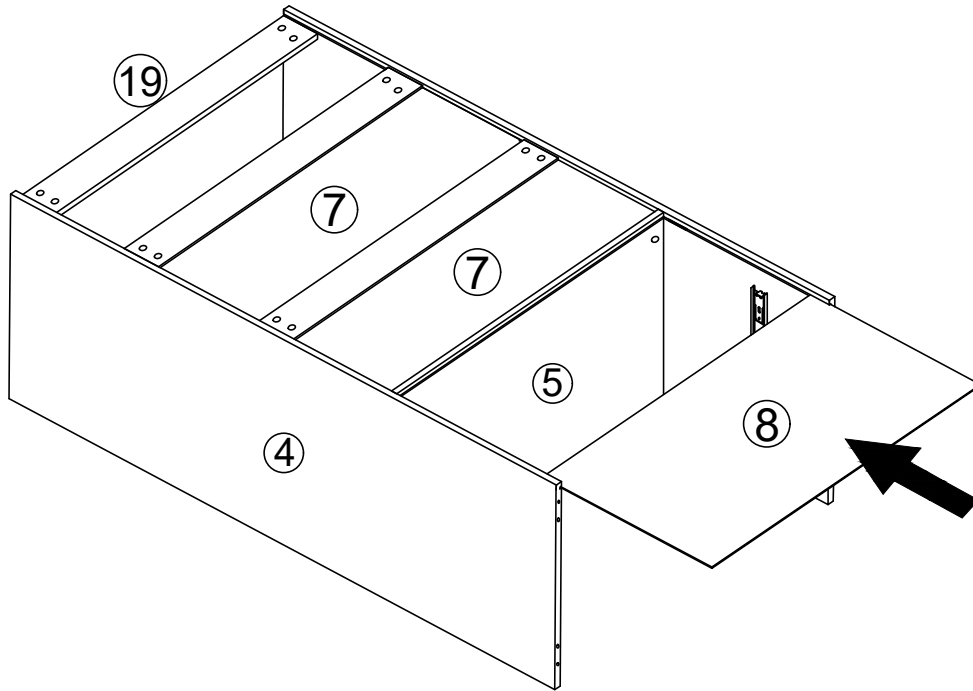

7. Assemble the back panel.

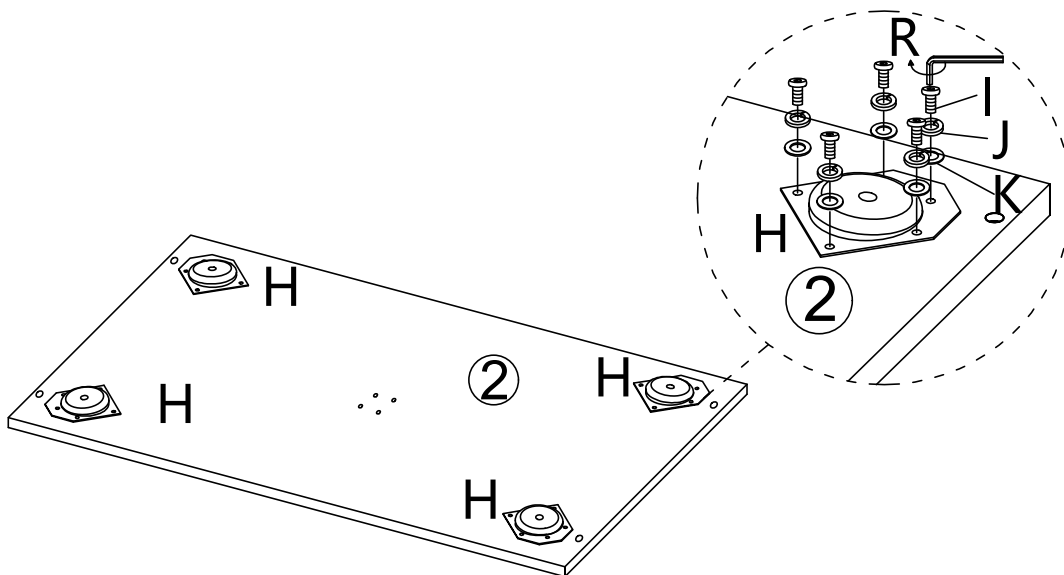

8. Attach the metal plate to the bottom panel.



H 	I 	J 	K 	R 
Metal Plate 4pcs	M6*14mm Bolt 20pcs	Spring Washer 20pcs	Lock Washer 20pcs	4mm Allen Key 1pc

9. Attach the bottom panel to the frame.

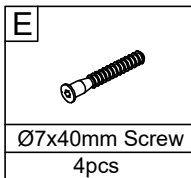
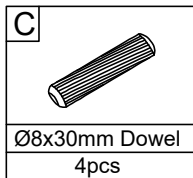
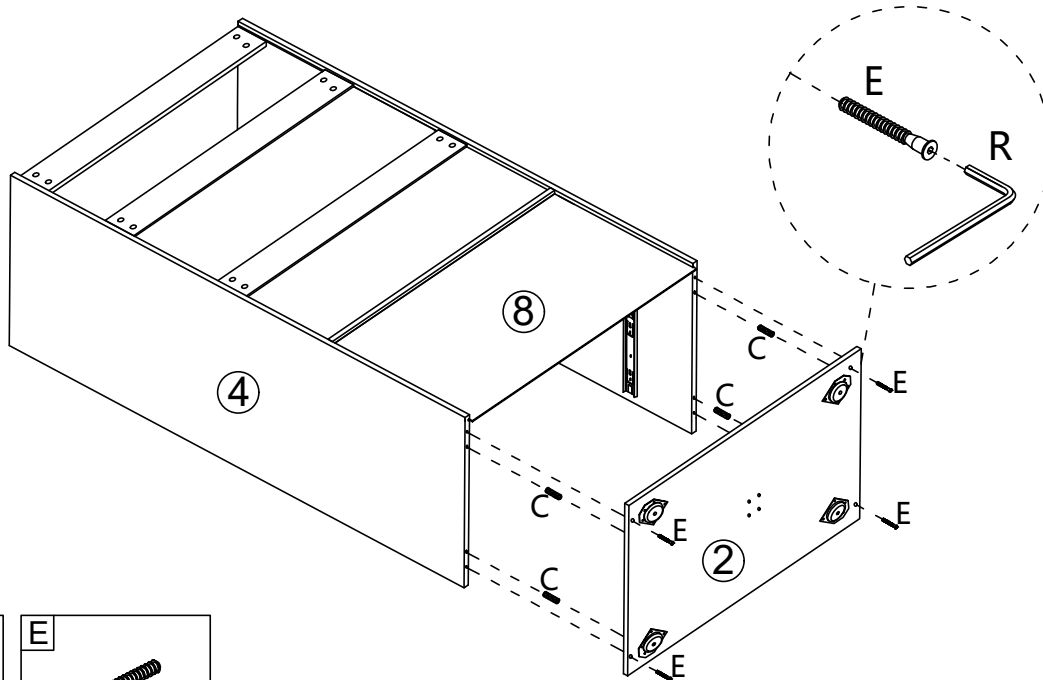

10. Attach middle leg to the frame.

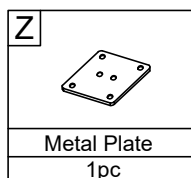
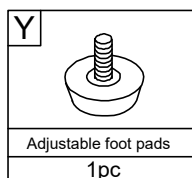
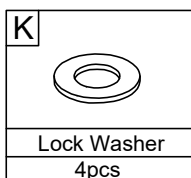
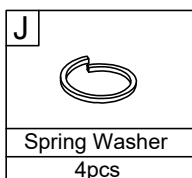
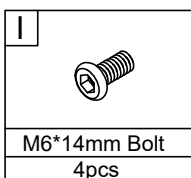
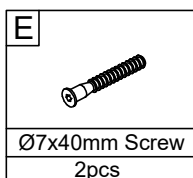
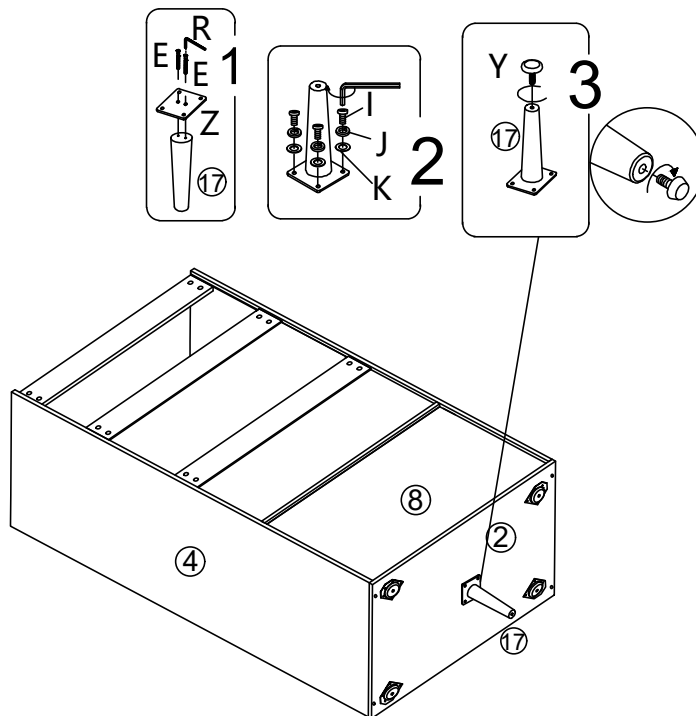

11. Attach legs to the frame.

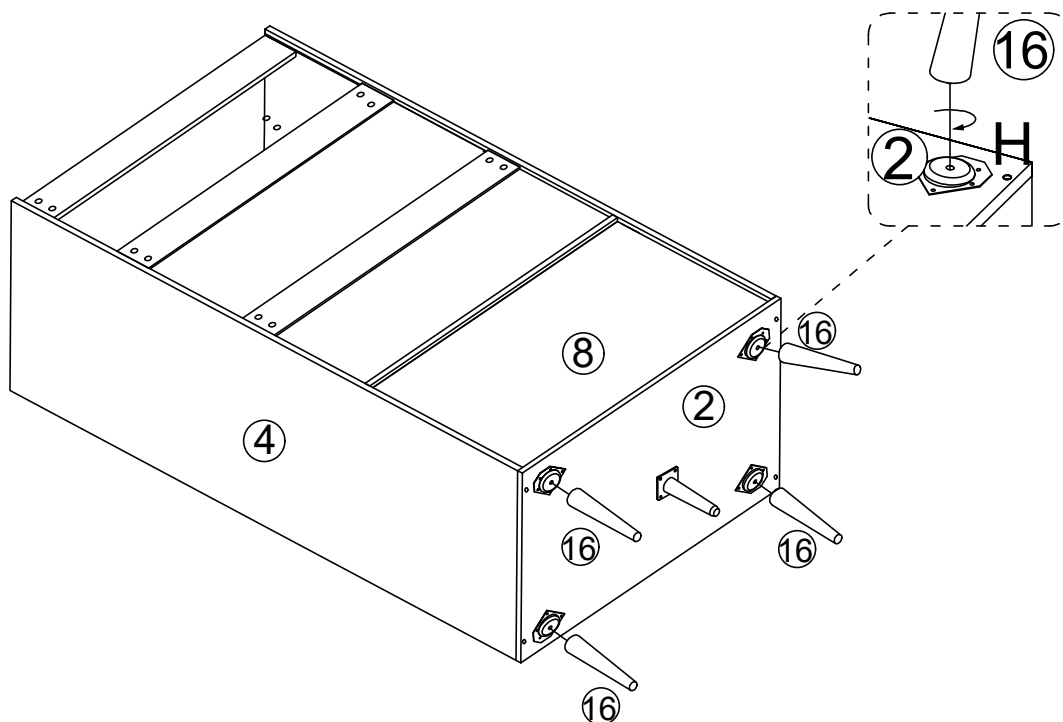

12. Assemble the back panel.

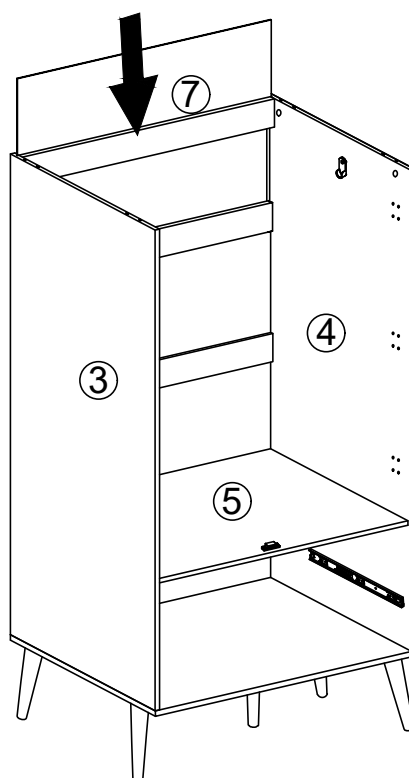

13. Attach the top panel to the frame.

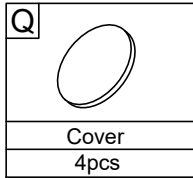
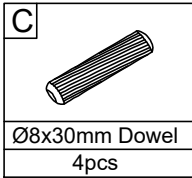
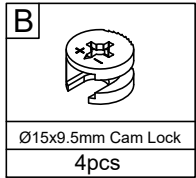
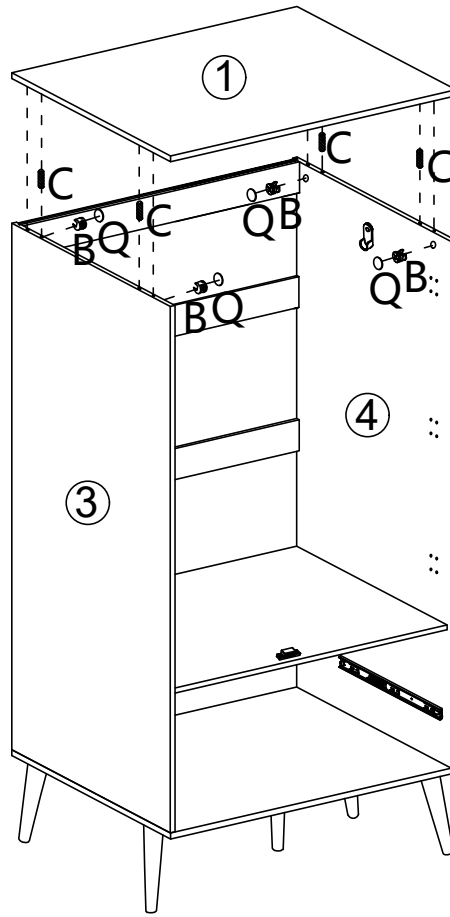
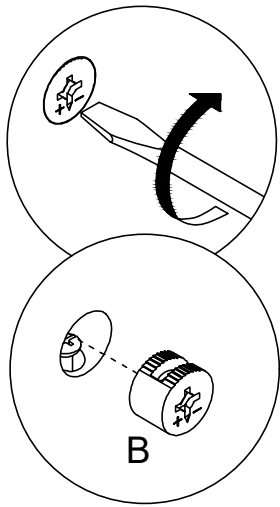

14. Attach hinges to the door.

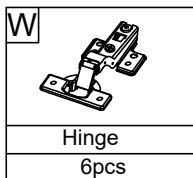
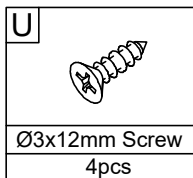
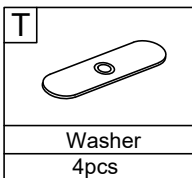
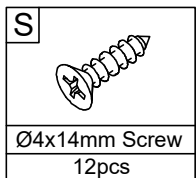
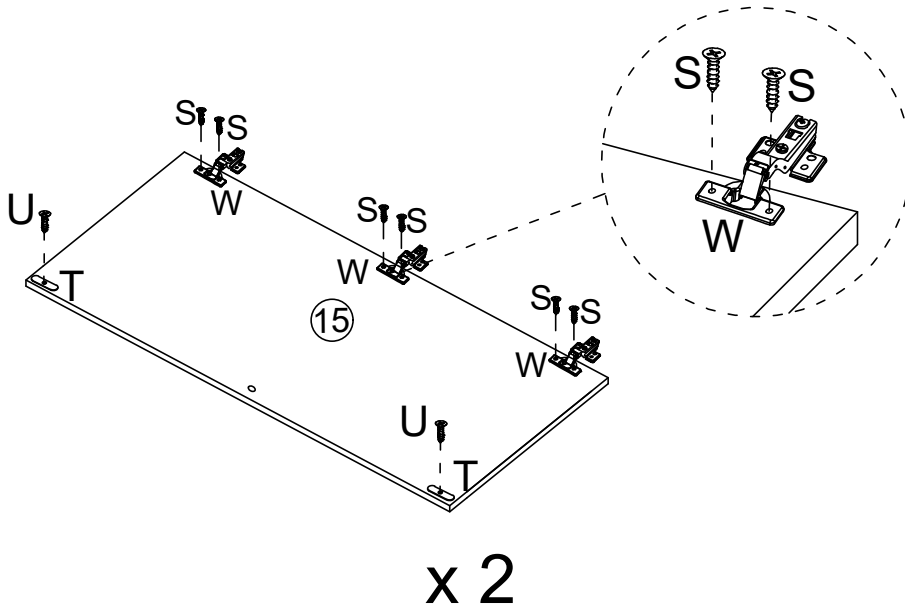

15. Attach door panels to the frame.

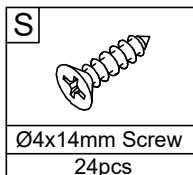
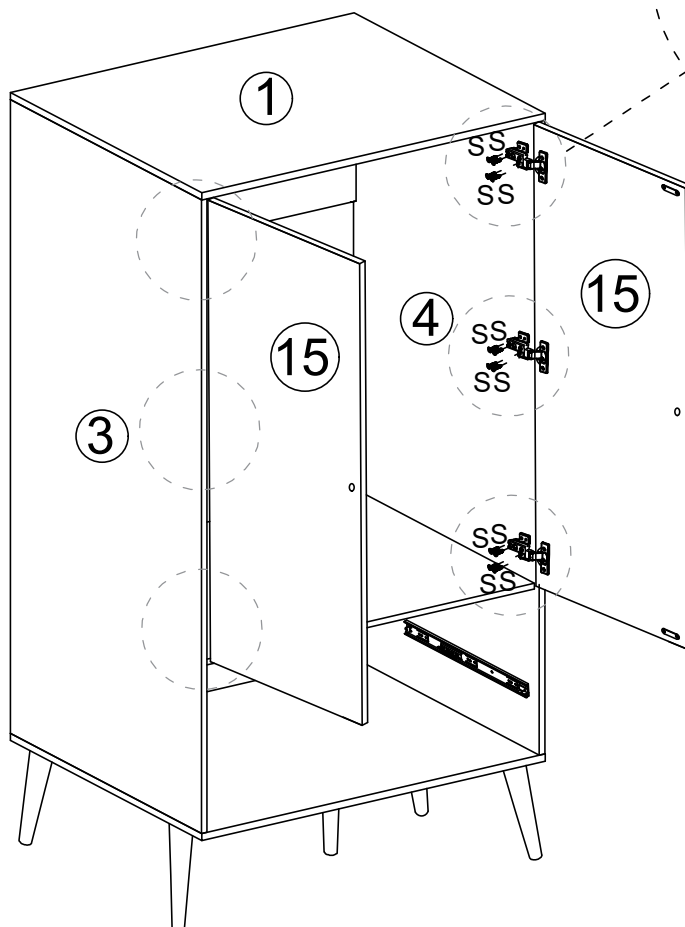
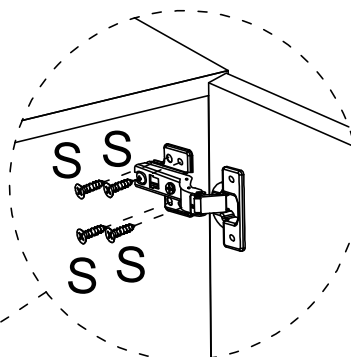
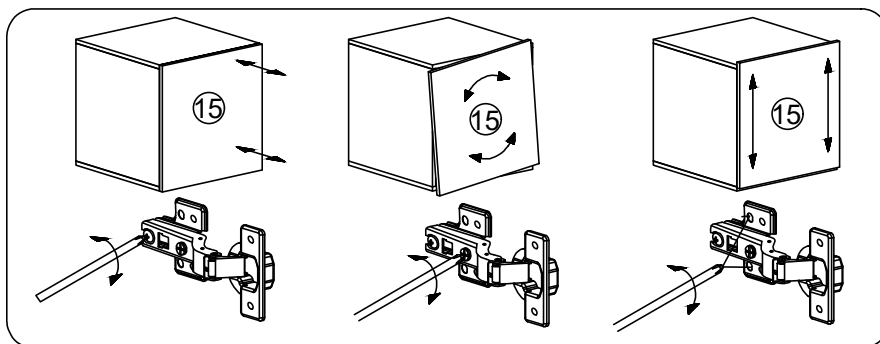



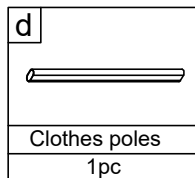
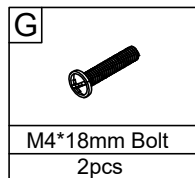
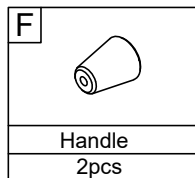
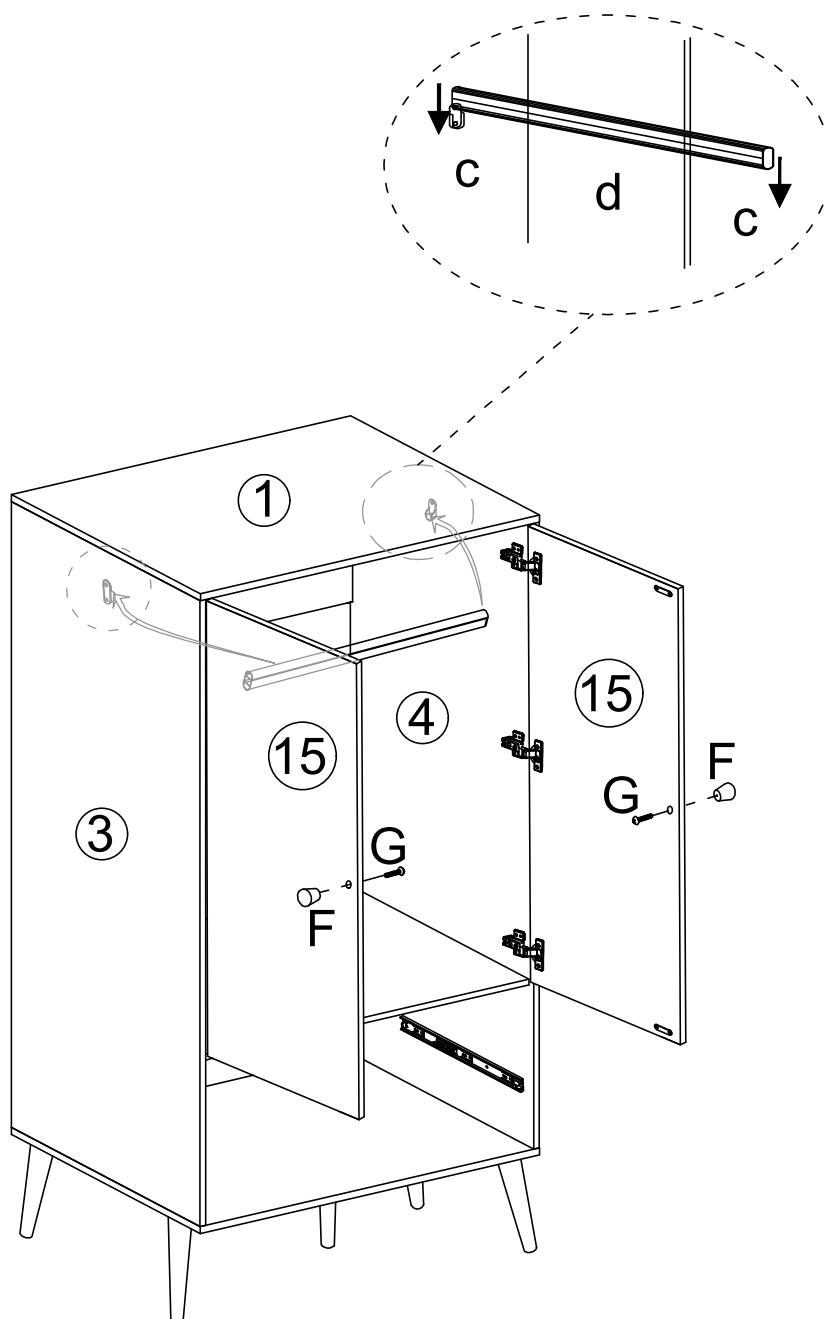

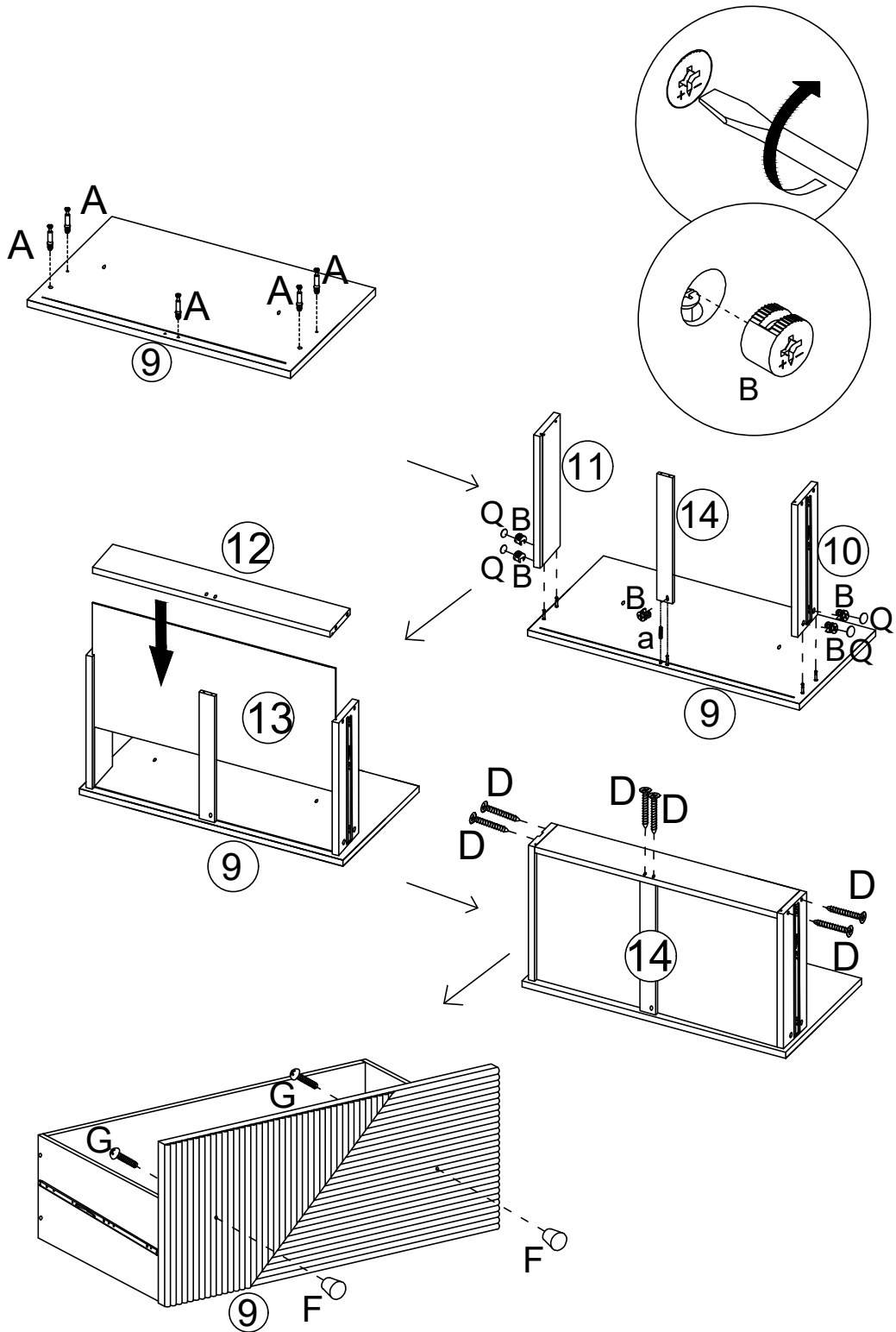

16. Assemble the clothes poles and handle.

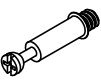

17. Assemble the drawer.



<p>A</p>  <p>M6*35mm Bolt 5pcs</p>	<p>B</p>  <p>Ø15x9.5mm Cam Lock 5pcs</p>	<p>D</p>  <p>Ø4x35mm Screw 6pcs</p>	<p>F</p>  <p>Handle 2pcs</p>
<p>G</p>  <p>M4*18mm Bolt 2pcs</p>	<p>Q</p>  <p>Cover 4pcs</p>	<p>a</p>  <p>Ø6x30mm Dowel 1pc</p>	

18. Assemble the drawer to the wardrobe.

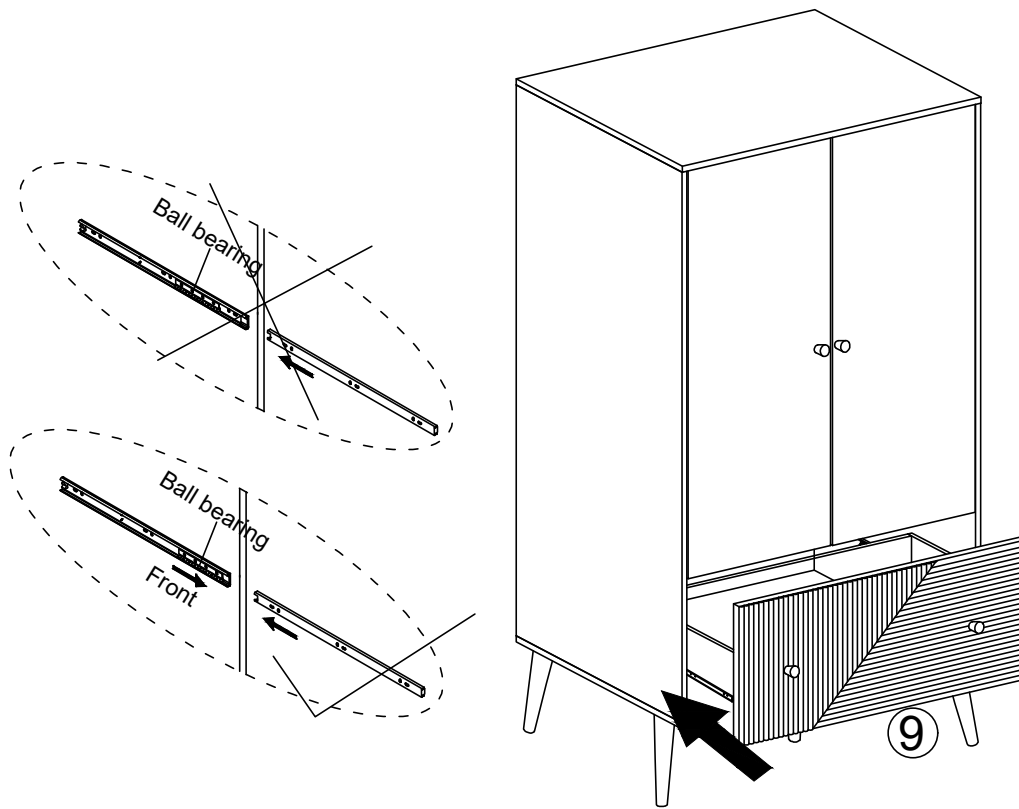

19. Attach the plastic buckle.

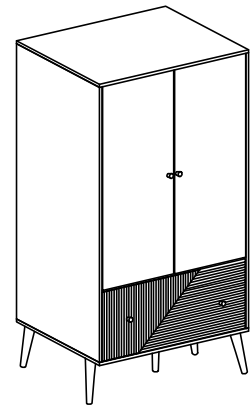
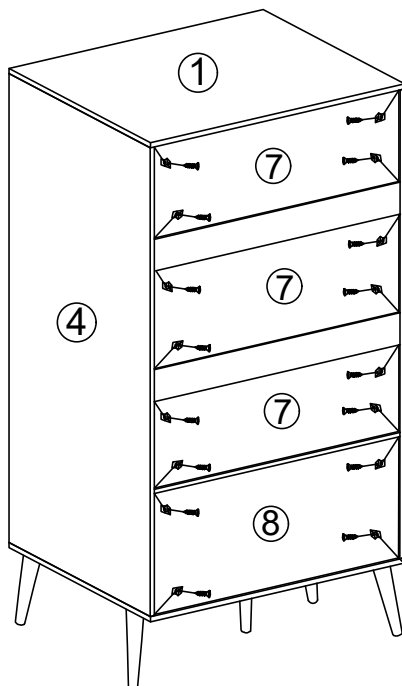

Manually adjust the frame slightly to ensure the drawers are in the correct position, even and parallel before attaching the plastic buckles.

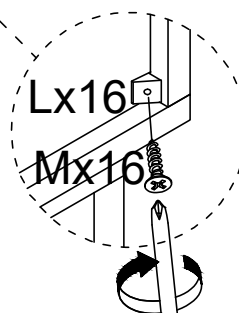
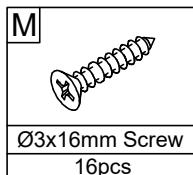
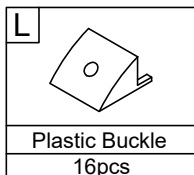

20. Attach the wall bracket.

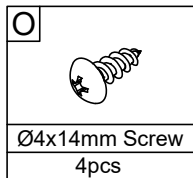
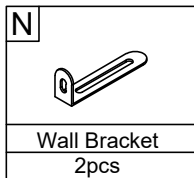
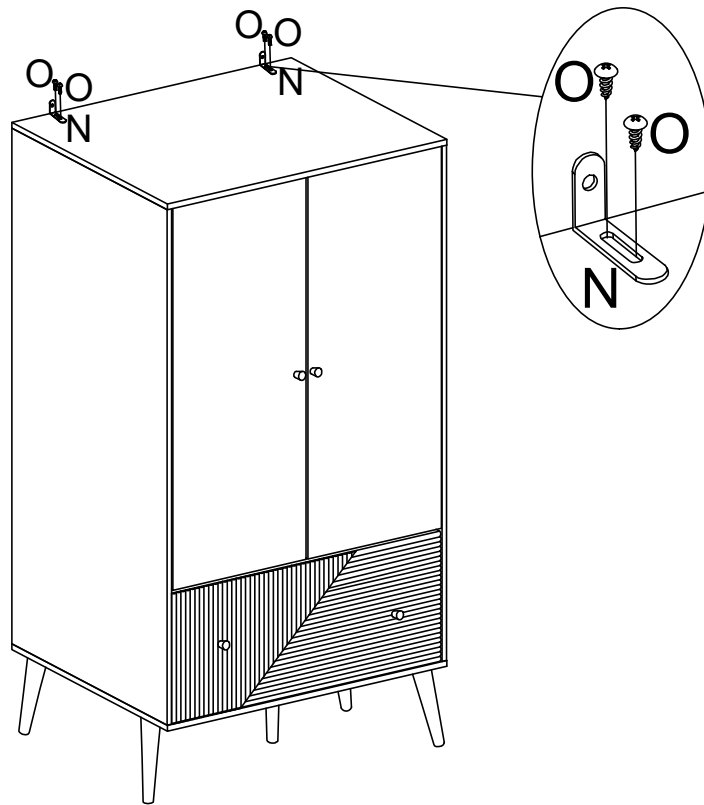

21. Fix the wall bracket to the wall.

