

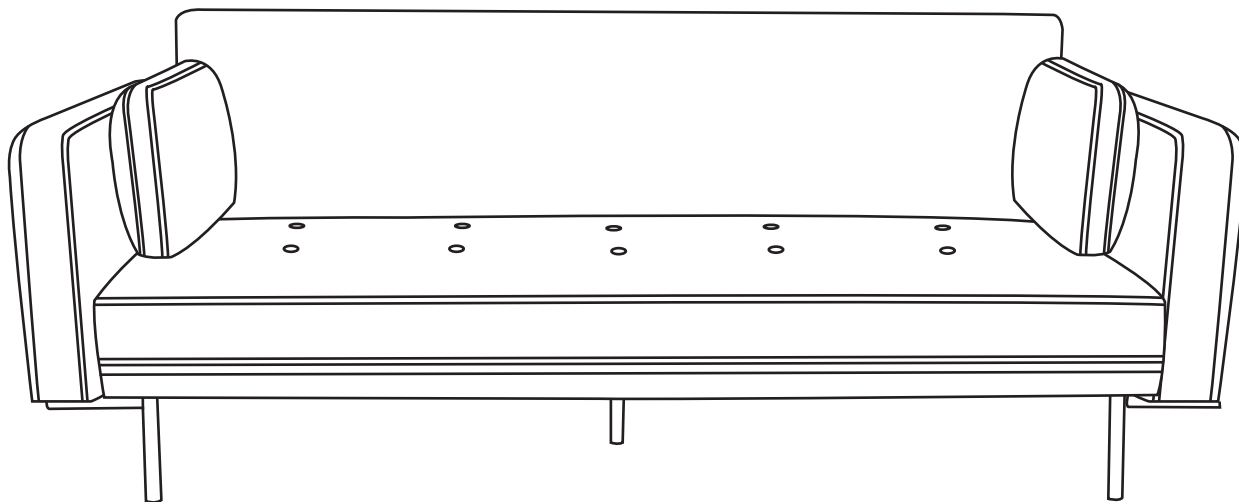











DUSK.COM

LIVING | BEDROOM | DINING

Hudson Click clack Sofa Bed
Box Dimensions:L181xW25xH111(cm)



<p>A</p> 	<p>B</p> 	<p>C</p> 	<p>D</p> 	<p>E</p> 	<p>F</p> 	<p>G</p> 
<p>Leg</p>	<p>M8X70MM</p>	<p>M8 Flat Washer</p>	<p>M6 Allen Key</p>	<p>Center Leg</p>	<p>M8X45MM</p>	<p>M8X25MM</p>
<p>4 PCS</p>	<p>8 PCS</p>	<p>20 PCS+2 Extra</p>	<p>1 PCS</p>	<p>1 PCS</p>	<p>8 PCS</p>	<p>4 PCS</p>
<p>H</p> 	<p>I</p> 		<p>J</p> 		<p>K</p> 	
<p>Cushion</p>	<p>Left armrest</p>		<p>Right armrest</p>		<p>Hardware base frame</p>	
<p>2 PCS</p>	<p>1 PCS</p>		<p>1 PCS</p>		<p>2 PCS</p>	



Up to 20 minutes
assembly time



Two person
assembly

V1.0

This product is intended for domestic use only, not commercial purposes

Page 1

Care and Maintenance

1. Clean with your vacuum curtain attachment (the one with a lint-catching fabric strip) or a lint roller to stop dust build up. Do this regularly to keep the sofa in its best condition.
2. Regularly plump the backrest pillows by shaking and squeezing to even out the filling.
3. Try to keep your sofa away from direct sunlight, and not too close to heat sources, as this can cause fading over time. Do not allow the sofa to make direct contact with any radiators or sources of heat.
4. Wipe up the spillages as quickly as possible by gently dabbing or blotting with a dry cloth until the mark fades away. Some tougher spills, such as oil and grease, can be more persistent and leave a stain. In this case, it's best to contact a specialist cleaning service.
5. Do not drag the sofa. When moving, lift the sofa off the floor.
6. Keep children and pets away from the assembly area and any packaging, small parts could choke or be swallowed.
7. Re-tighten all nuts and bolts after two weeks of use and regularly thereafter.
8. Do not sit on the arms of the sofa.
9. Do not jump on the sofa.
10. Only use the sofa on a flat and level surface.
11. Dispose of all packaging carefully and responsibly – recycle where possible.
12. This product is intended for domestic use only, not commercial purposes.
13. Keep hands away from the mechanism when opening or closing as this could cause entrapment.
14. Do not allow children to open the sofa bed.
15. Avoid sharp items such as toys, jean rivets, buckles etc from coming in contact with the fabric as these can easily snag, tear or pull the fabric.

Important

Assembly Tip

Before you begin, it's best to identify all of the parts and fittings to build your ottoman bed frame. We advise laying these out on the floor to check you have everything, and to familiarise yourself with all of the parts and fittings before building.

Top Tip

We recommend that you build your new ottoman bed frame in the room you'd like it to be located. This will help prevent any risk of damage to the frame whilst moving it.

Safety and Care

It's important to ensure children and animals are kept away from the assembly area, as there are small components used in this product which could present a choking hazard. All plastic and wrapping materials should also be kept away from children and animals to prevent any risk of suffocation.

Help and Support

Please contact our customer service team on 0113 519 0311 if you have any questions or issues with your purchase.

Recycling

Please ensure that packaging is disposed of in a safe and environmentally friendly way, and recycle where possible. Please keep your assembly instructions safe to refer back to in the future.

Step 1: Unzip the black fabric on the underside of the sofa bed to access the rest of the parts.

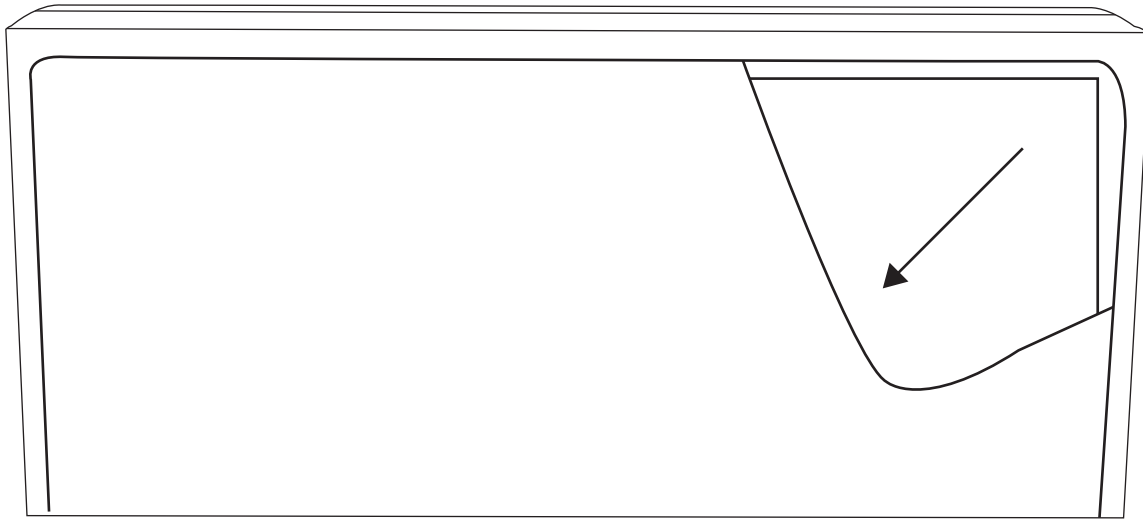

Step 2: Fasten the arms (I & J) to the sofa frame using 8x screw (B) and 8x washer(C) on each side.

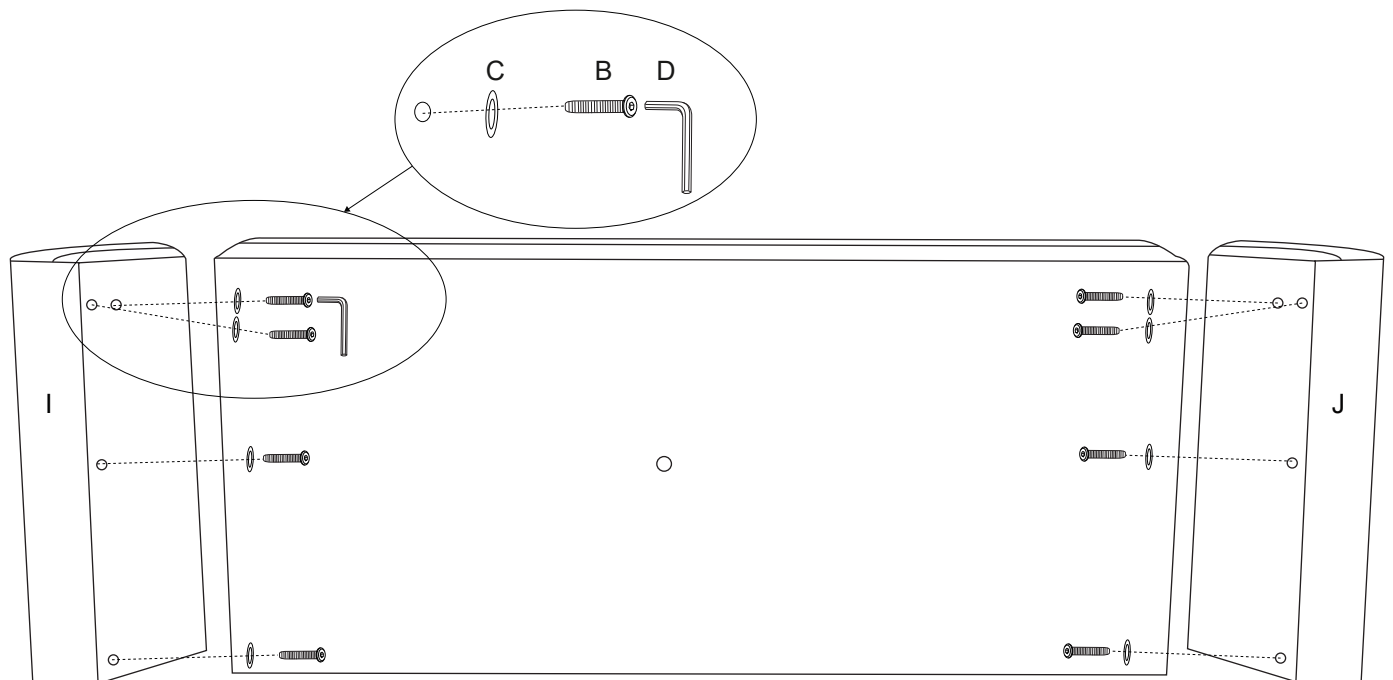

Step 3: Use the 4 screws (G) and 4x washer(C) on each side to attach the base frame (A) to the bottom of the sofa.

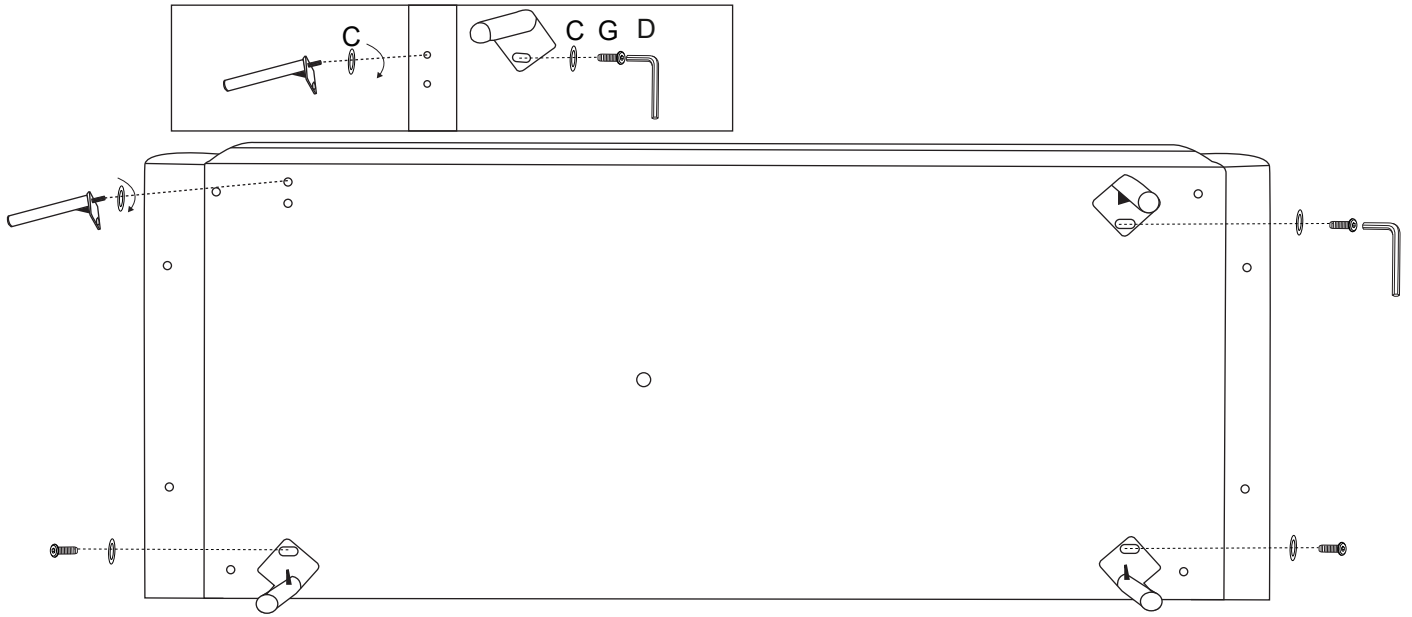

Step 4: Attach the legs (A, K& E) to the underside of the sofa using 8x screws (F) and 8x washer(C) on each side, being sure that leg (A) are at the front and (K) is at the back.

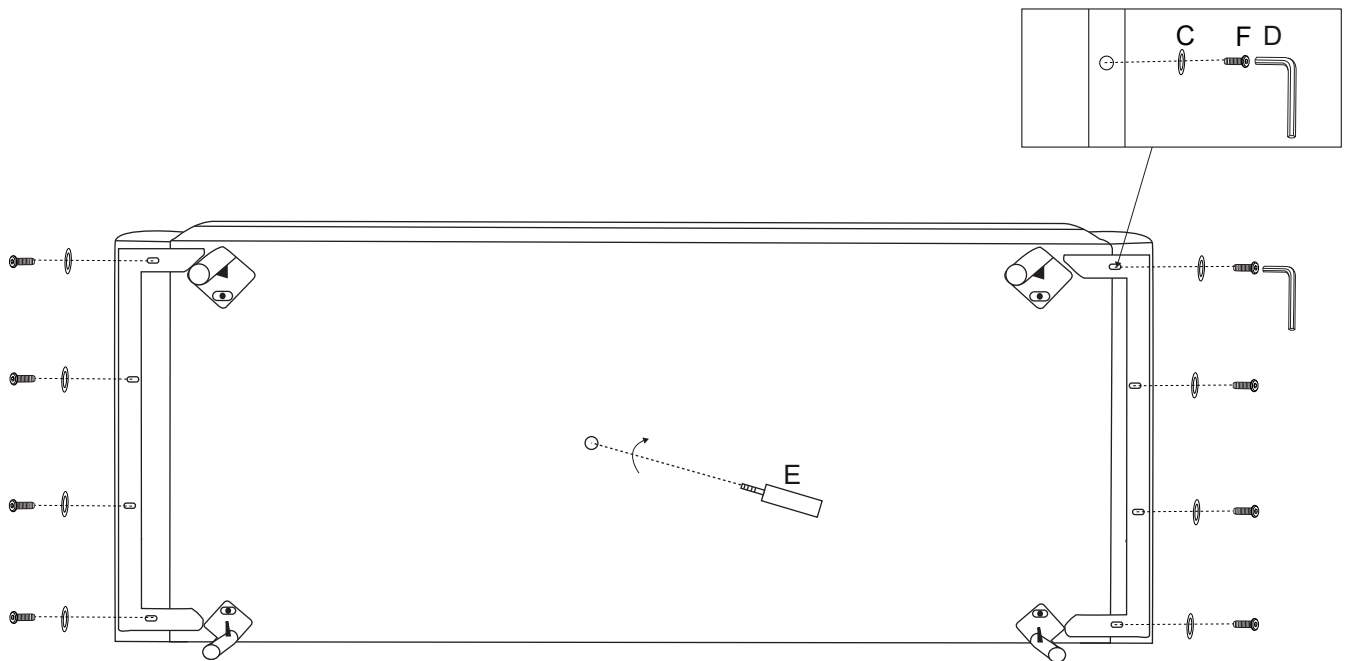

Warning: Please ensure the sofa bed is rotated with two people to prevent excess pressure on the back legs. Please ensure both persons evenly lower the sofa bed onto a level surface.

Step 5: To extend the legs, unzip the zipper on the back of the backrest, and pull the legs out until they lock into position.

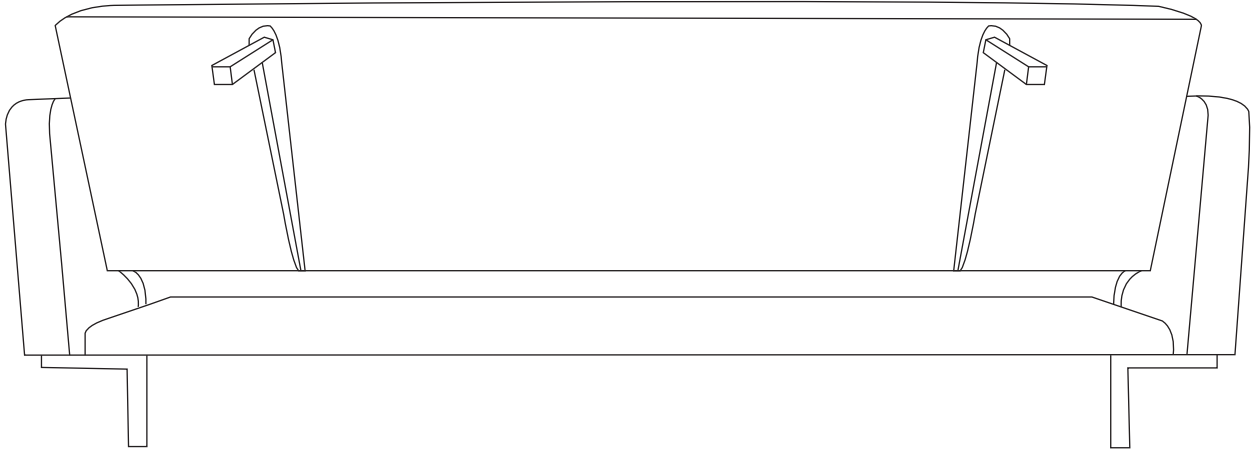

Step 6: To convert from the sofa position to the bed position, pull the backrest towards the front of the sofa until both the left and right side have clicked. proceed to lower the backrest down into the horizontal position.

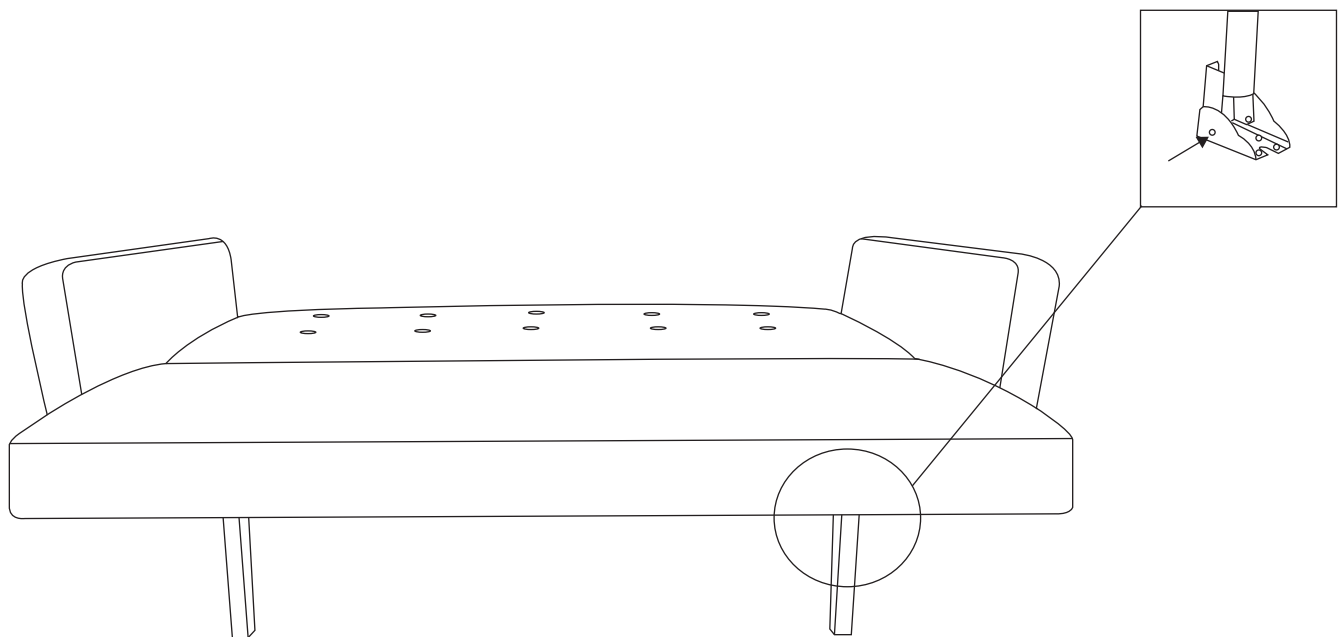

Step 7: To convert from the sofa bed to the sofa position, collapse the legs by pressing the latch at the top of the legs on the left hand side, being careful not to trap your fingers, fold the legs in and zip up the zipper. lift the sofa backrest and push it toward the front of the sofa until both sides click.

