

DUSK.COM

LIVING | BEDROOM | DINING

Matty Dining Chair
Box Dimensions: W73xD58xH36 (cm)
Product Dimensions: W54xD52xH79 (cm)

Matty Dining Chair

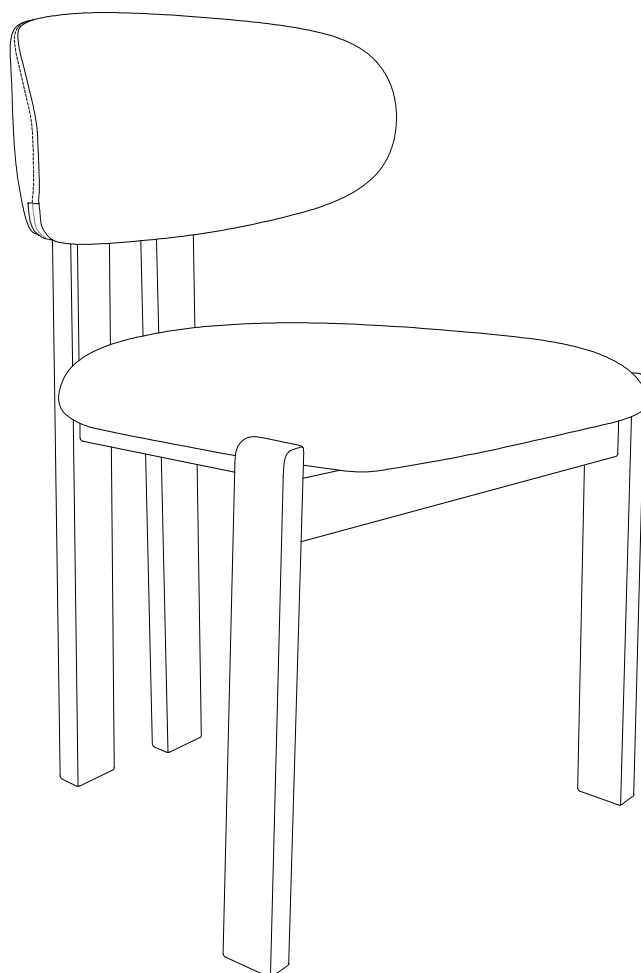

V2.0



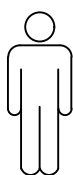

Up to 10 minutes
assembly time



One person
assembly



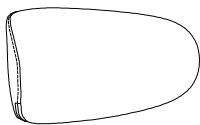
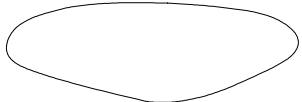

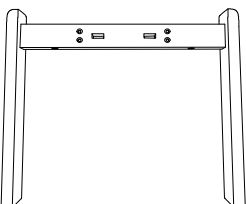
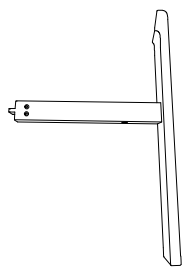
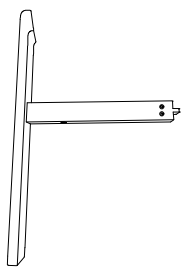

Page-1-5

Parts Check List

<div data-bbox="71 257 127 324" style="border: 1px solid black; padding: 2px; display: inline-block; font-weight: bold;">1</div> 	<div data-bbox="558 257 614 324" style="border: 1px solid black; padding: 2px; display: inline-block; font-weight: bold;">2</div> 	<div data-bbox="1053 257 1109 324" style="border: 1px solid black; padding: 2px; display: inline-block; font-weight: bold;">3</div> 
<p style="text-align: center;">Back 1pc</p>	<p style="text-align: center;">Seat 1pc</p>	<p style="text-align: center;">Connecting iron 2pcs</p>
<div data-bbox="71 761 127 828" style="border: 1px solid black; padding: 2px; display: inline-block; font-weight: bold;">4</div> 	<div data-bbox="558 761 614 828" style="border: 1px solid black; padding: 2px; display: inline-block; font-weight: bold;">5</div> 	<div data-bbox="1053 761 1109 828" style="border: 1px solid black; padding: 2px; display: inline-block; font-weight: bold;">6</div> 
<p style="text-align: center;">Front leg 1pc</p>	<p style="text-align: center;">Left rear leg 1pc</p>	<p style="text-align: center;">Right rear leg 1pc</p>

Fittings Check List

please check you have all the fittings listed below with you product

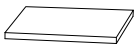
<div data-bbox="71 1433 127 1500" style="border: 1px solid black; padding: 2px; display: inline-block; font-weight: bold;">A</div> 	<div data-bbox="438 1433 494 1500" style="border: 1px solid black; padding: 2px; display: inline-block; font-weight: bold;">B</div> 	<div data-bbox="805 1433 861 1500" style="border: 1px solid black; padding: 2px; display: inline-block; font-weight: bold;">C</div> 	<div data-bbox="1173 1433 1228 1500" style="border: 1px solid black; padding: 2px; display: inline-block; font-weight: bold;">D</div> 
<p style="text-align: center;">M6*20MM 8pcs+1pc extra</p>	<p style="text-align: center;">6*12*1.2MM 6pcs+1pc extra</p>	<p style="text-align: center;">M6*50MM 4pcs+1pc extra</p>	<p style="text-align: center;">M6*35MM 2pcs+1pc extra</p>
<div data-bbox="71 1769 127 1836" style="border: 1px solid black; padding: 2px; display: inline-block; font-weight: bold;">E</div> 	<div data-bbox="438 1769 494 1836" style="border: 1px solid black; padding: 2px; display: inline-block; font-weight: bold;">F</div> 	<div data-bbox="805 1769 861 1836" style="border: 1px solid black; padding: 2px; display: inline-block; font-weight: bold;">G</div> 	
<p style="text-align: center;">M6 1pc</p>	<p style="text-align: center;">Wood cap 2pcs+1pc extra</p>	<p style="text-align: center;">Felt pad 2pcs extra</p>	

Step 1: Assemble these legs (4) (5) (6) with connecting iron (3).
Remember do not tighten fully until the structure is assembled.

A  8pcs

E  1pc

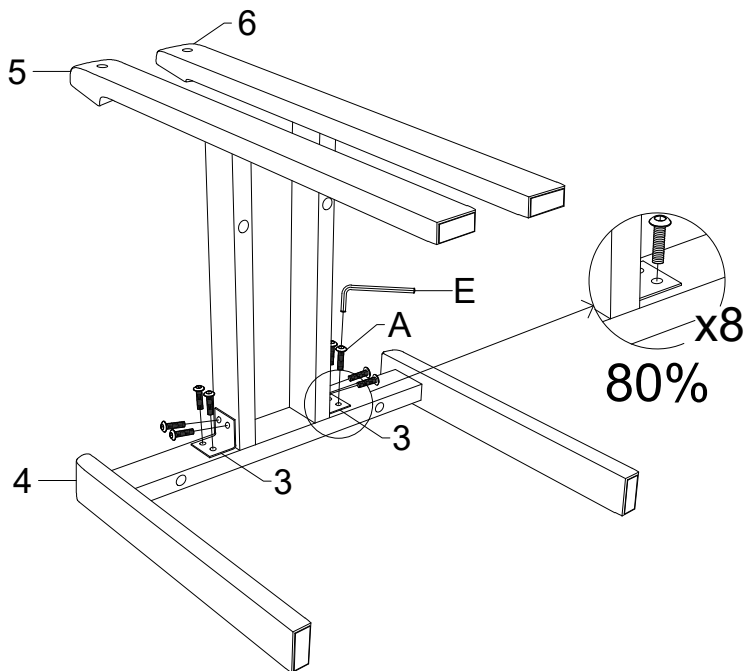

Step 2: Attach the seat (2) to the assembled legs.

B  4pcs

C  4pcs

E  1pc

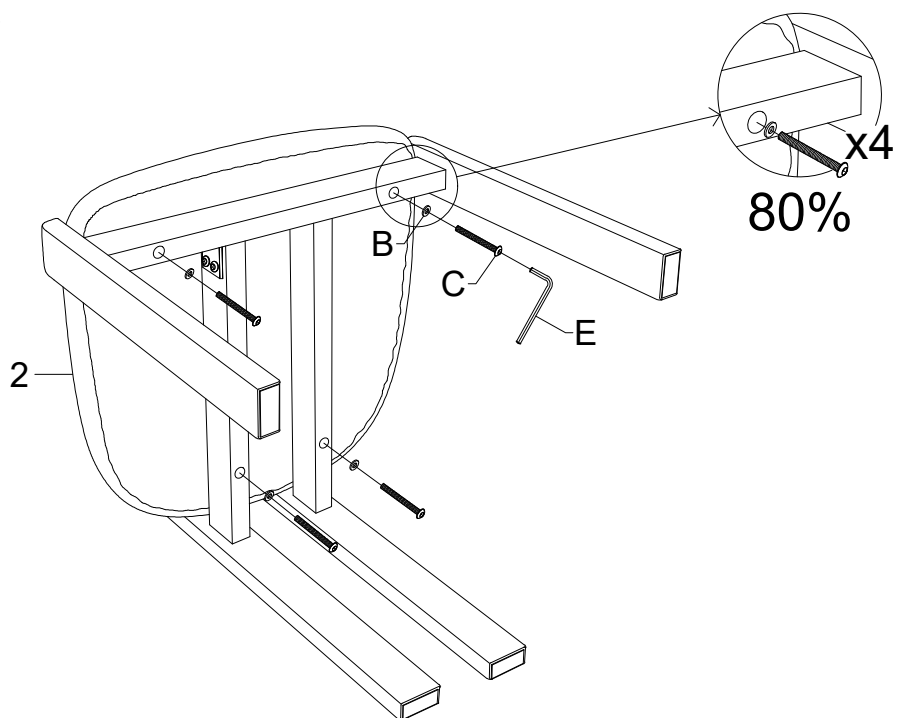

Step 3: Attach the back (1) to the assembled frame.

B  2pcs

D  2pcs

E  1pc

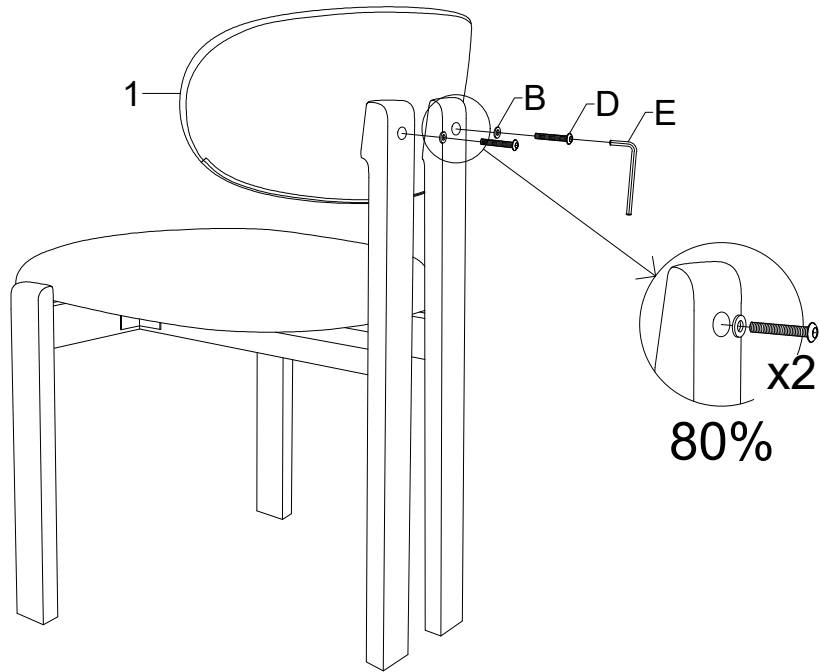

Step 4: Put the assembled chair onto a flat base and then fully tighten all bolts. Finally, insert the wood cap (F) .

F  2pcs

100%

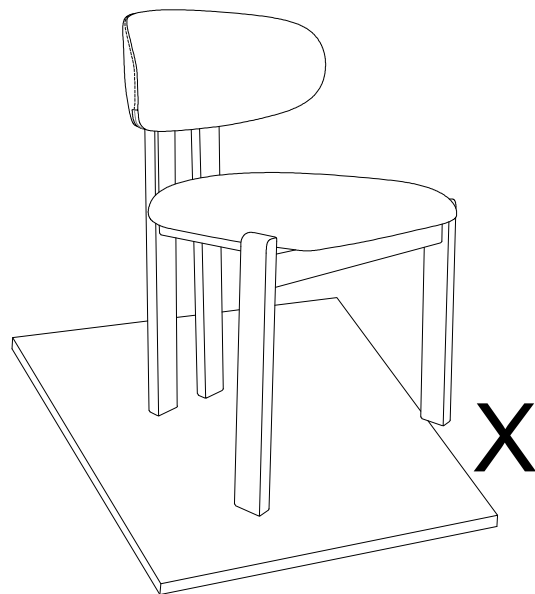
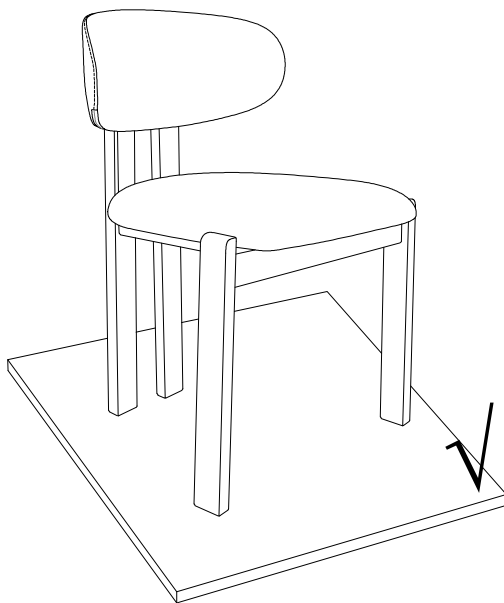

Care and Maintenance

- 1.Clean with your vacuum curtain attachment (the one with a lint-catching fabric strip) or a lint roller to stop dust build up.Do this regularly to keep the chair in its best condition.
- 2.Try to keep your chair away from direct sunlight, and not too close to heat sources, as this can cause fading over time.Do not allow the chair to make direct contact with any radiators or sources of heat.
- 3.Wipe up the spillages as quickly as possible by gently dabbing or blotting with a dry cloth until the mark fades away. Some tougher spills, such as oil and grease,can be more persistent and leave a stain. In this case, it's best to contact a specialist cleaning service.
- 4.Do not drag the chair. When moving, lift the chair off the floor.
- 5.Keep children and pets away while assembling the chair. Small parts could be a choking hazard.
- 6.Re-tighten all nuts and bolts after two weeks of use and regularly thereafter.
- 7.Do not sit on the arms of the chair.
- 8.Do not jump on the chair.
- 9.Only use the chair on a flat and level surface.
- 10.Dispose of all packaging carefully and responsibly - recycle where possible.
- 11.This product is intended for domestic use only, not commercial purposes.

Important

Assembly Tip

Before you begin, it's best to identify all of the parts and fittings to build your chair.

We advise laying these out on the floor to check you have everything, and to familiarise your-self with all of the parts and fittings before building.

Top Tip

We recommend that you build your new chair in the room you'd like it to be located. This will help prevent any risk of damage to the frame whilst moving it.

Safety and Care

It's important to ensure children and animals are kept away from the assembly area.As there are small components used in this product which could present a choking hazard.All plastic and wrapping materials should also be kept away from children and animals to prevent any risk of suffocation.

Help and Support

Please contact our customer service team on 0113 519 0311 if you have any questions or issues with your purchase.

Recycling

Please ensure that packaging is disposed of in a safe and environmentally friendly way, and recycle where possible.Please keep your assembly instructions safe to refer back to in the future.